



INDICE

CATALOGO - FONTANE & LUCI

- PAG 01 | LED ALTO RENDIMIENTO
 - PAG 01 B | LED ALTO RENDIMIENTO 3 in 1
 - PAG 01 C | LED ALTO RENDIMIENTO TUBO PER CASCADAS
 - PAG 01 D | LED ALTO RENDIMIENTO MINILED
 - PAG 01 E | LED ALTO RENDIMIENTO MINILED VX
 - PAG 01 F | LED ALTO RENDIMIENTO CORONA LED
 - PAG 01 G | LED ALTO RENDIMIENTO CON NICHOS
 - PAG 02 | CONTROLLER DMX 512 LED
 - PAG 03 | TOBERA S/JET
 - PAG 04 | TOBERA BIG S/JET
 - PAG 05 | TOBERA CASCADA
 - PAG 06 | TOBERA AGUA NIEVE
 - PAG 06 B | TOBERA AGUA NIEVE
 - PAG 07 | TOBERA FOAM GEISER
 - PAG 08 | TOBERA COLUMNA ANCHA
 - PAG 09 | TOBERA COLUMNA FINA
 - PAG 10 | TOBERA BORBOTON ESPUMOSO
 - PAG 11 | ESFERA DE AGUA
 - PAG 12 | SEMIESFERA DE AGUA
 - PAG 13 | TOBERA PULVERIZACION
 - PAG 14 | TOBERA VOLCANO
 - PAG 15 | TOBERA CORONA
 - PAG 16 | TOBERA COLUMNA DE AGUA
 - PAG 17 | TOBERA ABANICO DE CHORROS - ESPATULAS DE AGUA
 - PAG 18 | TOBERA CAMPANA BAJA - ALTA
 - PAG 19 | TOBERA CALIZ - CORONA - PALMERA
 - PAG 20 | TOBERA FUENTE SECA - PISCINAS - ROT HISBIS
 - PAG 21 | TOBERA PIROUETTE NEST - PIROUETTE
 - PAG 22 | TOBERA PANTALLA DE AGUA
 - PAG 23 | TOBERA JUMPING JET
 - PAG 25 | TOBERA NUBE PULVERIZACION
 - PAG 26 | TOBERA CORTINA HILO MYLAR
 - PAG 27 | FUENTES MUSICALES
 - PAG 28 A | WATER - MUSIC SWITCH
 - PAG 28 B | WATER - MUSIC CON NICHOS
 - PAG 28 C | WATER - MUSIC SWITCH DMX
 - PAG 28 D | WATER - MUSIC SWITCH
 - PAG 29 | TOBERA DUAL
 - PAG 30 | WATER - MUSIC BI-DIRECCIONAL
 - PAG 32 | FUENTES FLOTANTES
 - PAG 33 | WATER WALK
 - ACC 1 | SUMERGIBLE PUMPS
 - ACC 2 | PASAMUROS INOX
 - ACC 3 | ROTULAS - BRIDAS AJUSTABLES
 - ACC 4 | CAJA DE CONEXION - TOMAS DE FONDO
REBOSADEROS - APORTE DE AGUA
-



insieme a voi

Da quando siamo nati abbiamo sempre pensato che se vale la pena fare qualcosa, vale la pena **farla bene**.

Ecco perché il nostro team è formato da **professionisti appassionati** e con la voglia di affrontare ogni giorno le sfide che i nostri clienti ci propongono con il sorriso.

Un ringraziamento speciale va ai nostri **fondatori Aldo e Daniela**, che ci hanno trasmesso questi valori.

Per diventare grandi però bisogna anche guadagnarsi la fiducia e la collaborazione di **fornitori di alto livello** che condividono le nostre passioni, ai quali vogliamo dire il nostro sincero **GRAZIE!**



 Commercio Tubi e Raccordi in Plastica
info@mondiimpianti.com - www.mondiimpianti.com

 Installazione e Manutenzione Impianti
info@due-mondi.com - www.due-mondi.com

 Piscine - Wellness - Arredo Giardino
info@mondiverdi.it - www.mondiverdi.it

 e-Commerce
info@mondishop.it - www.mondishop.it



Handmade / Fait à la main

AR 111



Enganche, Hook



Brazo, Arm



Foco de Acero Inoxidable AISI-304, gran resistencia con 5 metros de cable. Lampara de Led de alto rendimiento, Led tipo "Cree" de alta potencia 3 en 1, gran poder de iluminación. Blanco, RGB y RGBW Potencias 15, 18 y 27W. IP 68.



Light Fixture made of Stainless steel AISI-304, big resistance with 5 meters of cable. Lamp of Led of high performance, Led type "Cree" high power, big power of lighting, 3 in 1. White, RGB & RGBW, Allow in 15, 18 and 27W. IP 68.



Projecteur d'Acier inoxydable AISI-304, une grande résistance, avec 5 mètres de câble. Projecteur de Led de haut rendement, Lampe de Led type "Cree" de haute puissance, 3 dans 1, de grand pouvoir d'éclairage. Disponible chez le Blanc, RGB et RGBW, Puissances 15, 18 et 27W. IP 68

LED ALTO RENDIMIENTO / HIGH POWER LED / LED de HAUT REDEMENT

TECHNICAL DATA



Handmade / Fait à la main

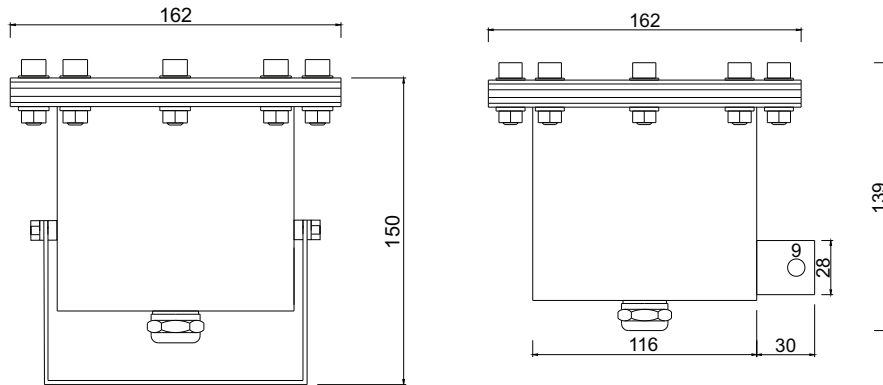

TYPE	DESCRIPCION AR111 con "U"	DESCRIPTION AR111 with "U"	Vatios Watts	Tesion Voltage	Temp Temp	Intensidad Intensity (lm)	Peso Weight	G. Proteccion P-Grade
WLT 77007	Led Cree Foco Led Cree 15W Blanco Calido WW Int.	Light Fixture Cree 15W Warm White WW Spot	15W	12/24VDC	3000K	900-1000lm	2,7Kg	IP 68
WLT 77008	Led Cree Foco Led Cree 15W Blanco Frio CW Int.	Light Fixture Cree 15W Cold White CW Spot	15W	12/24VDC	5500K	900-1000lm	2,7Kg	IP 68
WLT 77009	Led Cree Foco Led Cree 15W Blanco Calido WW Ext.	Light Fixture Cree 15W Warm White WW Flood	15W	12/24VDC	3000K	900-1000lm	2,7Kg	IP 68
WLT 77010	Led Cree Foco Led Cree 15W Blanco Frio CW Ext.	Light Fixture Cree 15W Cold White CW Flood	15W	12/24VDC	5500K	900-1000lm	2,7Kg	IP 68
WLT 77011	Led Cree Foco Led Cree 18W Blanco Calido WW Int.	Light Fixture Cree 18W Warm White WW Spot	18W	12/24VDC	3000K	1400-1600lm	2,7Kg	IP 68
WLT 77012	Led Cree Foco Led Cree 18W Blanco Frio CW Int.	Light Fixture Cree 18W Cold White CW Spot	18W	12/24VDC	5500K	1400-1600lm	2,7Kg	IP 68
WLT 77013	Led Cree Foco Led Cree 27W Blanco Calido WW Int.	Light Fixture Cree 27W Warm White WW Spot	27W	12/24VDC	3000K	1800-2000lm	2,7Kg	IP 68
WLT 77014	Led Cree Foco Led Cree 27W Blanco Frio CW Int.	Light Fixture Cree 27WCold White CW Spot	27W	12/24VDC	5500K	1800-2000lm	2,7Kg	IP 68
WLT 7701615	Led Cree Foco Led Cree 15W RGB 3 en 1	Light Fixture Cree 15W RGB 3 in 1	15W	12/24VDC		800-900lm	2,7Kg	IP 68
WLT 7701718	Led Cree Foco Led Cree 18W RGB 3 en 1	Light Fixture Cree 18W RGB 3 in 1	18W	12/24VDC		1200-1400lm	2,7Kg	IP 68
WLT 7701827	Led Cree Foco Led Cree 27W RGB 3 en 1	Light Fixture Cree 27W RGB 3 in 1	27W	12/24VDC		1500-1800lm	2,7Kg	IP 68
WLT 77016154	Led Cree Foco Led Cree 15W RGBW 4 en 1	Light Fixture Cree 15W RGBW 4 in 1	15W	12/24VDC		1200-1500lm	2,7Kg	IP 68
WLT 77017184	Led Cree Foco Led Cree 18W RGBW 4 en 1	Light Fixture Cree 18W RGBW 4 in 1	18W	12/24VDC		2000-2300lm	2,7Kg	IP 68
WLT 77018274	Led Cree Foco Led Cree 27W RGBW 4 en 1	Light Fixture Cree 27W RGBW 4 in 1	27W	12/24VDC		2200-2500lm	2,7Kg	IP 68
TYPE	DESCRIPCION AR111 con Gancho	DESCRIPTION AR111 with Hook	Vatios Watts	Tesion Voltage	Temp Temp	Intensidad Intensity (Cd)	Peso Weight	G. Proteccion P-Grade
WLT 77023	Led Cree Foco Led Cree 15W Blanco Calido WW Int.	Light Fixture Cree 15W Warm White WW Spot	15W	12/24VDC	3000K	900-1000lm	2,7Kg	IP 68
WLT 77024	Led Cree Foco Led Cree 15W Blanco Frio CW Int.	Light Fixture Cree 15W Cold White CW Spot	15W	12/24VDC	5500K	900-1000lm	2,7Kg	IP 68
WLT 77025	Led Cree Foco Led Cree 15W Blanco Calido WW Ext.	Light Fixture Cree 15W Warm White WW Flood	15W	12/24VDC	3000K	900-1000lm	2,7Kg	IP 68
WLT 77026	Led Cree Foco Led Cree 15W Blanco Frio CW Ext.	Light Fixture Cree 15W Cold White CW Flood	15W	12/24VDC	5500K	900-1000lm	2,7Kg	IP 68
WLT 77027	Led Cree Foco Led Cree 18W Blanco Calido WW Int.	Light Fixture Cree 18W Warm White WW Spot	18W	12/24VDC	3000K	1400-1600lm	2,7Kg	IP 68
WLT 77028	Led Cree Foco Led Cree 18W Blanco Frio CW Int.	Light Fixture Cree 18W Cold White CW Spot	18W	12/24VDC	5500K	1400-1600lm	2,7Kg	IP 68
WLT 77029	Led Cree Foco Led Cree 27W Blanco Calido WW Int.	Light Fixture Cree 27W Warm White WW Spot	27W	12/24VDC	3000K	1800-2000lm	2,7Kg	IP 68
WLT 77030	Led Cree Foco Led Cree 27W Blanco Frio CW Int.	Light Fixture Cree 27WCold White CW Spot	27W	12/24VDC	5500K	1800-2000lm	2,7Kg	IP 68
WLT 7703215	Led Cree Foco Led Cree 15W RGB 3 en 1	Light Fixture Cree 15W RGB 3 in 1	15W	12/24VDC		800-900lm	2,7Kg	IP 68
WLT 7703218	Led Cree Foco Led Cree 18W RGB 3 en 1	Light Fixture Cree 18W RGB 3 in 1	18W	12/24VDC		1200-1400lm	2,7Kg	IP 68
WLT 7703227	Led Cree Foco Led Cree 27W RGB 3 en 1	Light Fixture Cree 27W RGB 3 in 1	27W	12/24VDC		1500-1800lm	2,7Kg	IP 68
WLT 77032154	Led Cree Foco Led Cree 15W RGBW 4 en 1	Light Fixture Cree 15W RGBW 4 in 1	15W	12/24VDC		1200-1500lm	2,7Kg	IP 68
WLT 77032184	Led Cree Foco Led Cree 18W RGBW 4 en 1	Light Fixture Cree 18W RGBW 4 in 1	18W	12/24VDC		2000-2300lm	2,7Kg	IP 68
WLT 77032274	Led Cree Foco Led Cree 27W RGBW 4 en 1	Light Fixture Cree 27W RGBW 4 in 1	27W	12/24VDC		2200-2500lm	2,7Kg	IP 68



Temperatura de Color Colour Temperature	Grados Kelvin Grados Kelvin Grades	Efectos Asociados (Ambiente) Associate effects (Ambience)	Aplicaciones Recomendadas Recommended application
Calido / Warm	2600-3400K	Amigable / Friendly Intimo / Intime Personal / Personal Exclusivo / Exclusive	Restaurantes / Restaurants Lobbies Librerías / Bookstores Oficinas / Offices
Neutral / Neutral	3500K	Amigable / Friendly Incitante / Inciting	Recepciones / Main hall Exposiciones / Exhibitions Librerías / Bookstores Oficinas / Offices
Frio / Cold	3600-4900K	Fresco / Fresh Limpio / Clean Eficiente / Efficient	Oficinas / Offices Salon Conferencias / Conferences lounge Escuelas / Schools Hospitales / Hospitals
Luz de día / Day light	5000K	Impersonal / Impersonal Dinámico / Dynamic Limpio / Clean	Joyerías / Jewelry Consultorias / Consultacias Imprentas / Printing Hospitales / Hospitals



Handmade / Fait à la main

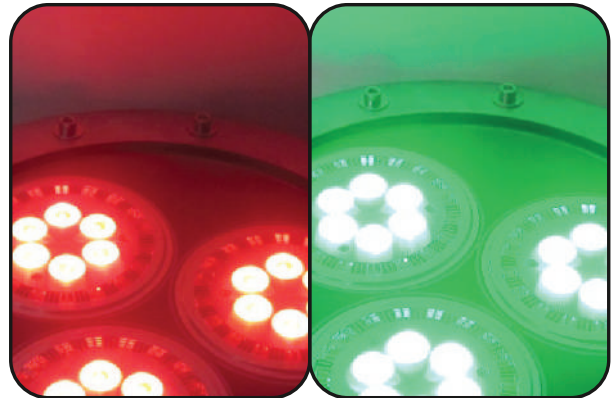

FOCO TRIPLE ALTO RENDIMIENTO / TRIPLE HIGH POWER LED / TRIPLE LED de HAUT REDEMENT



Foco de Acero Inoxidable AISI-304, gran resistencia con 5 metros de cable. Lampara de Led de alto rendimiento, Led tipo Cree de alta potencia, gran poder de iluminación. Blanco, RGB y RGBW, Potencias 45, 54 y 81W. IP 68.



Light Fixture made of Stainless steel AISI-304, big resistance with 5 meters of cable. Lamp of Led of high performance, Led type "Cree" high power, big power of lighting. White, RGB and RGBW, Allow in 45, 54 and 81W. IP 68.



Projecteur d'Acier inoxydable AISI-304, une grande résistance, avec 5 mètres de câble. Projecteur de Led de haut rendement, Lampe de Led type "Cree" de haute puissance, de grand pouvoir d'éclairage. Disponible chez le Blanc, RGB et RGBW, Puissances 45, 54 et 81W. IP 68



LED ALTO RENDIMIENTO / HIGH POWER LED / LED de HAUT REDEMENT

TECHNICAL DATA

Handmade / Fait à la main

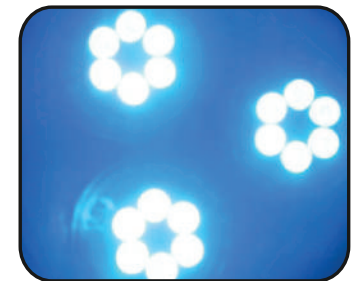
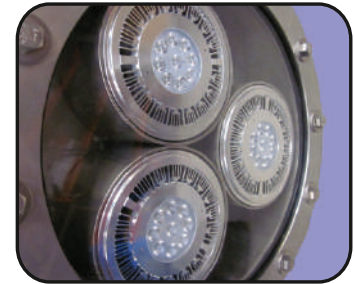
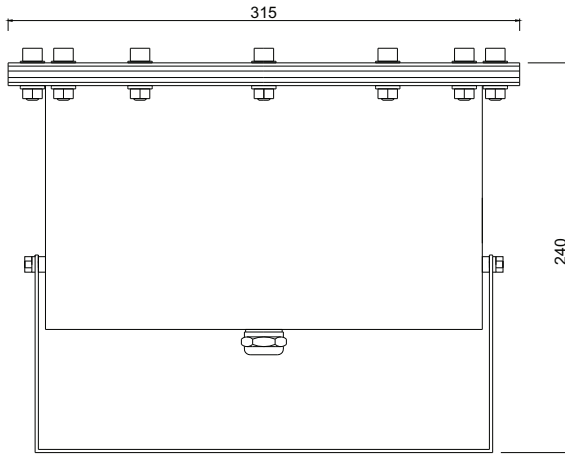

TYPE	DESCRIPCION	DESCRIPTION	Vatios Watts	Tesion Voltage	Temp Temp	Intensidad Intensity (lm)	Peso Weight	G. Protecion P- Grade
WLT 77038	Led Cree Triple Foco Led Cree 3x15W Blanco Calido WW Int.	Triple Light Fixture Cree 3x15W Warm White WW Spot	45W	12/24VDC	3000K	2700-3000lm	7Kg	IP 68
WLT 77039	Led Cree Triple Foco Led Cree 3x15W Blanco Frio CW Int.	Triple Light Fixture Cree 3x15W Cold White CW Spot	45W	12/24VDC	5500K	2700-3000lm	7Kg	IP 68
WLT 77040	Led Cree Triple Foco Led Cree 3x15W Blanco Calido WW Ext.	Triple Light Fixture Cree 3x15W Warm White WW Flood	45W	12/24VDC	3000K	2700-3000lm	7Kg	IP 68
WLT 77041	Led Cree Triple Foco Led Cree 3x15W Blanco Frio CW Ext.	Triple Light Fixture Cree 3x15W Cold White CW Flood	45W	12/24VDC	5500K	2700-3000lm	7Kg	IP 68
WLT 77042	Led Cree Triple Foco Led Cree 3x18W Blanco Calido WW Int.	Triple Light Fixture Cree 3x18W Warm White WW Spot	54W	12/24VDC	3000K	4200-4800lm	7Kg	IP 68
WLT 77043	Led Cree Triple Foco Led Cree 3x18W Blanco Frio CW Int.	Triple Light Fixture Cree 3x18W Cold White CW Spot	54W	12/24VDC	5500K	4200-4800lm	7Kg	IP 68
WLT 77044	Led Cree Triple Foco Led Cree 3x27W Blanco Calido WW Int.	Triple Light Fixture Cree 3x27W Warm White WW Spot	81W	12/24VDC	3000K	5400-6000lm	7Kg	IP 68
WLT 77045	Led Cree Triple Foco Led Cree 3x27W Blanco Frio CW Int.	Triple Light Fixture Cree 3x27W Cold White CW Spot	81W	12/24VDC	5500K	5400-6000lm	7Kg	IP 68
WLT 7704845	Led Cree Triple Foco Led Cree 3x15W RGB 3 en 1	Triple Light Fixture Cree 3x15W RGB 3 in 1	45W	12/24VDC		2400-2700lm	7Kg	IP 68
WLT 7704860	Led Cree Triple Foco Led Cree 3x18W RGB 3 en 1	Triple Light Fixture Cree 3x18W RGB 3 in 1	54W	12/24VDC		3600-4200lm	7Kg	IP 68
WLT 7704890	Led Cree Triple Foco Led Cree 3x27W RGB 3 en 1	Triple Light Fixture Cree 3x27W RGB 3 in 1	81W	12/24VDC		4500-5400lm	7Kg	IP 68
WLT 77048454	Led Cree Triple Foco Led Cree 3x15W RGBW 4 en 1	Triple Light Fixture Cree 3x15W RGBW 4 in 1	45W	12/24VDC		3600-4500lm	7Kg	IP 68
WLT 77048604	Led Cree Triple Foco Led Cree 3x18W RGBW 4 en 1	Triple Light Fixture Cree 3x18W RGBW 4 in 1	54W	12/24VDC		6000-6900lm	7Kg	IP 68
WLT 77048904	Led Cree Triple Foco Led Cree 3x27W RGBW 4 en 1	Triple Light Fixture Cree 3x27W RGBW 4 in 1	81W	12/24VDC		6600-7500lm	7Kg	IP 68

Handmade / Fait à la main

TECHNICAL DATA

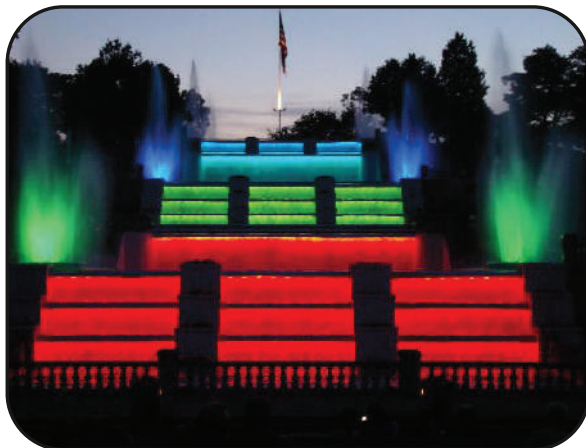

FIJACIONES / MECHANICAL FASTENERS

**TUBO LED PARA CASCADAS / TUBE OF LED FOR WATER FALLS
/ TUBE DE LED POUR LES NATUREL CASCADE D'EAU**



Foco especial para iluminación de cascadas naturales de agua, fabricado en metacrilato y acero inoxidable AISI-304, de gran resistencia, con 2 metros de cable. Led de alto rendimiento, Led tipo Samsung 5050 de alta potencia, gran poder de iluminación. Blanco, RGB y RGBW 15W metro RGB, 15W metro Blanco. IP68.



Special lighting for natural cascades of water, made of methacrylate and stainless steel AISI-304, big resistance, with 2 meters of cable. High performance Led, Led Samsung 5050 type, high power of lighting. White, RGB and RGW 15W per meter RGB, 15W White per meter. IP68



Éclairage spécial pour les cascades naturelles d'eau, faite de methacrylate et d'acier inoxydable AISI-304, grande résistance, avec 2 mètres de câble. Haute performance Samsung 5050 type, haut pouvoir d'éclairage. Blanc, RGB et RGBW, 15W par mètre RGB, 15W Blanc par mètre. IP68



Handmade / Fait à la main

LED ALTO RENDIMIENTO / HIGH POWER LED / LED de HAUT REDEMENT

TECHNICAL DATA

TUBO LED PARA CASCADAS / TUBE OF LED FOR WATER FALLS / TUBE DE LED POUR LES NATUREL CASCADE D'EAU

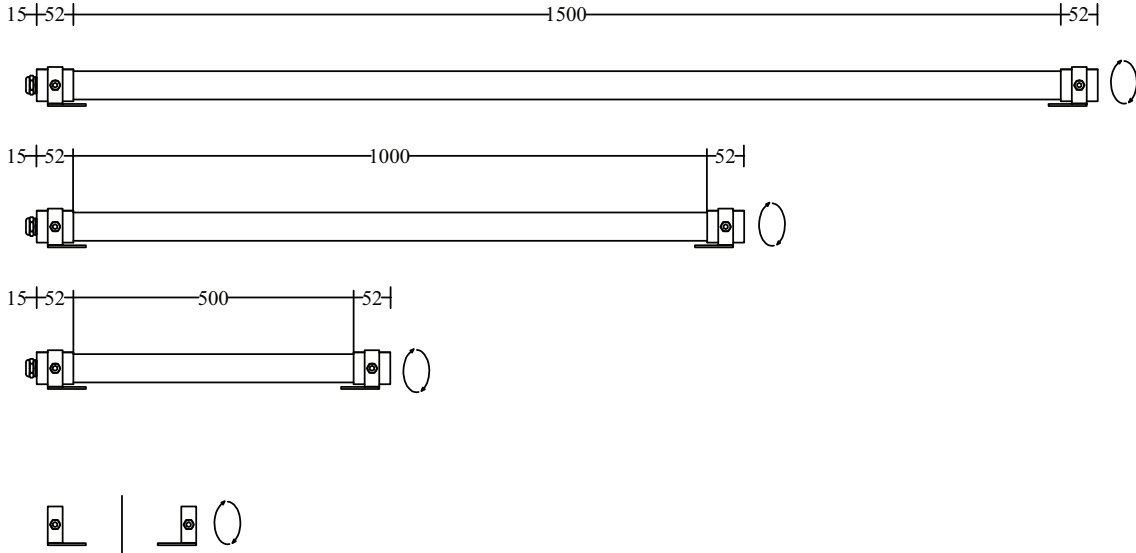

2 METROS DE CABLE INCLUIDO		2 METERS CABLE LENGHT INCLUDED		N. Led	Tesion	Vatios	Intensidad	Peso	G. Proteccion
WLT	Tubo de Led para Cascadas, Blanco Cálido, Alta Potencia.	Light Fixture Tube for Water Falls, Hgh Power Led, Warm White.	Led No.	Voltage	Wats	Intensity (Cd)	Weight	P- Grade	
WLT 771105	0,50m	0,50m	30	24VDC	7,5W	550-700lm	0,75Kg	IP 68	
WLT 771110	1,00m	1,00m	60	24VDC	15W	1100-1300lm	1,46Kg	IP 68	
WLT 771115	1,50m	1,50m	90	24VDC	22,5W	1800-2100lm	2,20Kg	IP 68	
WLT 77004	0,50m	0,50m	30	24VDC	7,5W	550-700lm	0,75Kg	IP 68	
WLT 771106	1,00m	1,00m	60	24VDC	15W	1100-1300lm	1,46Kg	IP 68	
WLT 771111	1,50m	1,50m	90	24VDC	22,5W	1800-2100lm	2,20Kg	IP 68	
WLT 771116	0,50m	0,50m	30	24VDC	7,5W	550-700lm	0,75Kg	IP 68	
WLT 7711064	1,00m	1,00m	60	24VDC	15W	1100-1300lm	1,46Kg	IP 68	
WLT 7711114	1,50m	1,50m	90	24VDC	22,5W	1800-2100lm	2,20Kg	IP 68	

¡¡Para mas potencia de iluminacion, por favor, preguntar!!

For more Power of brightness, please, request!!

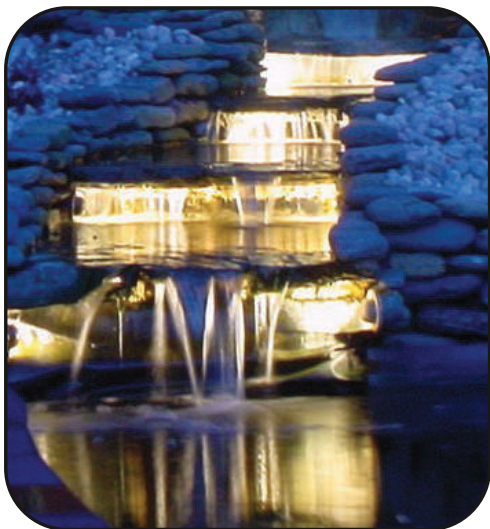



Handmade / Fait à la main

MINI FOCO DE LED / MINI LED LIGHT FIXTURE / MINI PROJECTEUR DE LED
2 METROS DE CABLE INCLUIDO / 2 METER CABLE LENGHT INCLUDED
LENGHT CÂBLÉ DE 2 MÈTRES INCLUS

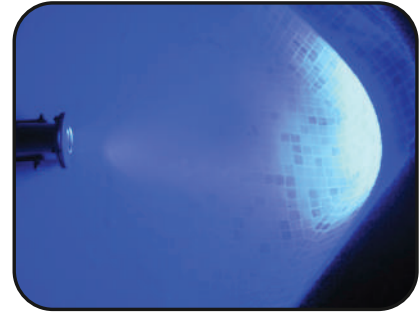
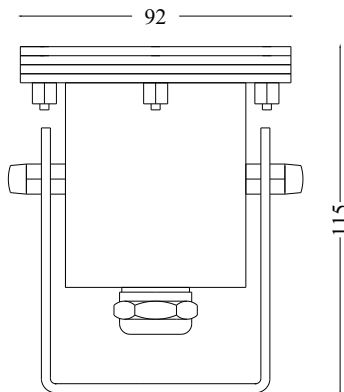

	MINI FOCO DE LED INOX CON BRAZO "U"	MINI LED LIGHT FIXTURE S. STEEL LIGHT	Vatios	Intensidad	Tension	Peso	Grado P
	2 METROS CABLE	WITH ARM "U", 2 METERS CABLE LENGHT	Wattios	Intensity (lm)	Voltage	Weight	P. Grade
WLT 77062	Mini Foco de Led 12V, 5W. Blanco Extensivo	Mini Led Light Fixture 12V. 5W. White Flood	5W	450-500lm	12VAC/DC	1,050 Kg	IP68
WLT 77063	Mini Foco de Led 12V, 5W. Blanco Intensivo	Mini Led Light Fixture 12V. 5W. White Spot	5W	450-500lm	12VAC/DC	1,050 Kg	IP68
WLT 77066	Mini Foco de Led 12V, 3W. RGB Automatico	Mini Led Light Fixture 12V. 3W. RGB Autochanging	3W	270-300lm	12VDC	1,050 Kg	IP68
WLT 770656	Mini Foco de Led 12V, 6W. RGB Int/Ext, 3 en 1	Mini Led Light Fixture 12V. 6W. RGB Spot/Flood, 3 in 1	6W	480-500lm	12VDC	1,050 Kg	IP68
WLT 7706564	Mini Foco de Led 12V, 6W. RGBW Int/Ext, 4 en 1	Mini Led Light Fixture 12V. 6W. RGBW Spot/Flood, 4 in 1	6W	600-700lm	12VDC	1,050 Kg	IP68



Foco tamaño mini para iluminación fuentes de agua, fabricado en acero inoxidable AISI-304, de gran resistencia, con 2 metros de cable. Led de alto rendimiento, Led tipo "cree" de alta potencia, gran poder de iluminación. Blanco 5W, RGB 6W y RGBW 6W. . IP 68. RGB con cuatro o cinco cables., para usar con controlador y elegir el color exacto en cada momento.



Mini size light fixture for water fountains and ponds, made in stainless steel AISI-304, great resistance, with 2 meters of cable. Led of high power, Led diode "cree" high potency, big power of lighting. White 5W, RGB 6W & RGBW 6W. IP 68. RGB with four or five wires to use with controler and to choose the exact color in every moment.



Éclairage, Appareil de lumière Mini, pour les fontaines d'eau et les étangs, faits dans l'acier inoxydable AISI-304, grande résistance, avec 2 mètres de câble. Mené du haut pouvoir, diode Menée "cree" haute puissance, grand pouvoir d'éclairage. Blanc 5W, RGB 6W et RGBW 6W. IP 68. RGB avec quatre ou cinq fils pour utiliser avec controler et choisir la couleur exacte à chaque



Handmade / Fait à la main

MINI VX FOCO DE LED 2xPG-16 / MINI VX LED LIGHT FIXTURE 2xPG-16 / MINI VX PROJECTEUR DE LED 2xPG-16

METROS DE CABLE BAJO PEDIDO Y CABLEADO / METER CABLE LENGHT UNDER ORDER / CÂBLE DE MÈTRE LENGHT SELON L'ORDRE

Model VX Size 2xPG-16

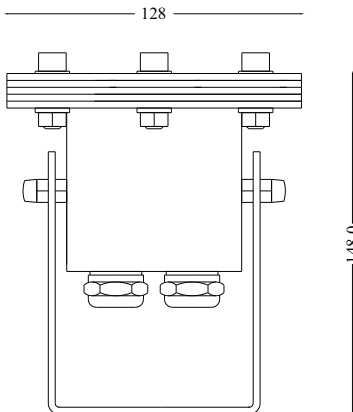

MINI VX FOCO DE LED INOX CON BRAZO "U" METROS CABLE BAJO PEDIDO		MINI VX LED LIGHT FIXTURE S. STEEL LIGHT WITH ARM "U", CABLE LENGHT UNDER ORDER	Vatios	Intensidad	Tension	Peso	Grado P
			Wattios	Intensity (lm)	Voltage	Weight	P. Grade
WLT 770656W VX	Mini VX Foco de Led 12V, 5W. Blanco Int/Ext	Mini VX Led Light Fixture 12V. 5W. White Spot/Flood	5W	450-500lm	12VAC/DC	1,150 Kg	IP68
WLT 770656 VX	Mini VX Foco de Led 12V, 6W. RGB, 3 en 1 Int/Ext	Mini VX Led Light Fixture 12V. 6W. RGB, 3 in 1 Spot/Flood	6W	480-500lm	12VDC	1,150 Kg	IP68
WLT 7706564 VX	Mini VX Foco de Led 12V, 6W. RGBW, 4 en 1, Int/Ext	Mini VX Led Light Fixture 12V. 6W. RGBW, 4 in 1 Spot/Flood	6W	600-700lm	12VDC	1,150 Kg	IP68



Foco tamaño mini para iluminación fuentes de agua, fabricado en acero inoxidable AISI-304, de gran resistencia, cable bajo pedido. Led de alto rendimiento, Led tipo "cree" de alta potencia, gran poder de iluminación. Blanco 5W, RGB y RGBW 6W, IP 68. RGB con cuatro o cinco cables para usar con controlador y elegir el color exacto en cada momento



Mini size light fixture for water fountains and ponds, made in stainless steel AISI-304, great resistance, cable under order. Led of high power, Led diode "cree" high potency, big power of lighting. White 5W. RGB & RGBW 6W. IP 68. RGB with four or five wires to use with controler and to choose the exact color in every moment.



Éclairage, Appareil de lumière Mini, pour les fontaines d'eau et les étangs, faits dans l'acier inoxydable AISI-304, grande résistance, câble selon l'ordre. Mené du haut pouvoir, diode Menée "cree" haute puissance, grand pouvoir d'éclairage. Blanc 5W. RGB et RGBW 6W. IP 68. RGB avec quatre ou cinq fils pour utiliser avec controler et choisir la couleur exacte à chaque

LED ALTO RENDIMIENTO / HIGH POWER LED / LED de HAUT REDEMENT

TECHNICAL DATA



CORONA DE LED ACERO INOX / CROWN OF LED STAINLESS STEEL / COURONNE DE LED L'ACIER INOXYDABLE

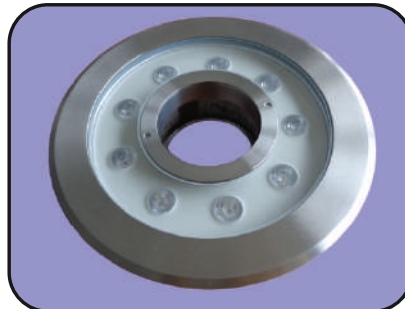

MODELO "A" / MODEL "A" / MODÈLE "A"



MODELO "B" / MODEL "B" / MODÈLE "B"

REFERENCE	MODEL	MEASUREMENTS		
		WIDE	HEIGHT	HOLE
WLT 77080A	A	250 mm	80 mm	81 mm
WLT 77084A	A	250 mm	80 mm	81 mm
WLT 77081B	B	230 mm	75 mm	42 mm
WLT 770814B	B	230 mm	75 mm	42 mm
WLT 77082C	C	180 mm	75 mm	42 mm
WLT 770824C	C	180 mm	75 mm	42 mm

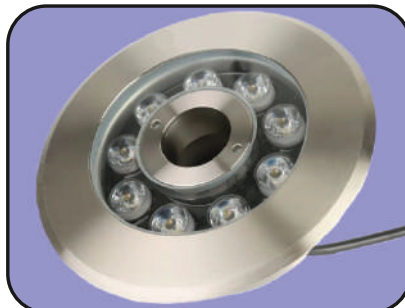

MODELO "C" / MODEL "C" / MODÈLE "C"



REFERENCE	TYPE	MODEL	CORONA LED ACERO INOX	CROWN OF LED STAINLESS STEEL	Wattios	Tesion	Temp	Intensidad	Peso	G. Proteccion
					Watts	Voltage	Temp	Intensity (lm)	Weight	P- Grade
WLT 77080A	Led Cree	A	Corona Led 9x3W Blanco Calido WW Int.	Crown Led 9x3W Warm White WW Spot	27W	24VDC	3000K	2500 lm	3,1 Kg	IP 68
WLT 77084A	Led Cree	A	Corona Led 9x5W RGBWW Calido Int.	Crown Led 9x5W RGBWW Warm Int.	45W	24VDC	RGBW	3500-4000 lm	3,1 Kg	IP 68
WLT 77081B	Led Cree	B	Corona Led 9x3W Blanco Calido WW Ext.	Crown Led 9x3W Warm White WW Flood	27W	24VDC	3000K	2500 lm	2,1 Kg	IP 68
WLT 770814B	Led Cree	B	Corona Led 9x5W RGBWW Calido Int.	Crown Led 9x5WRGBWW Warm Int.	45W	24VDC	RGBW	3500-4000 lm	2,1 Kg	IP 68
WLT 77082C	Led Cree	C	Corona Led 9x3W Blanco Calido WW Int.	Crown Led 9x3W Warm White WW Spot	27W	24VDC	3000K	2500 lm	1,7 Kg	IP 68
WLT 770824C	Led Cree	C	Corona Led 9x5W RGBWW Calido Int.	Crown Led 9x5W RGBWW Warm Int.	45W	24VDC	RGBW	3500-4000 lm	1,7 Kg	IP 68



Foco en forma de corona o anillo de led, este foco permite la iluminación alrededor del chorro de agua, consiguiendo una iluminación mas repartida igualmente en todas las partes del chorro de agua. Fabricado en acero inoxidable AISI-304, de gran resistencia, cable bajo pedido. Led de alto rendimiento, Led tipo "cree" de alta potencia, gran poder de iluminación. Blanco 27W, RGB y RGBW 45W, IP 68. RGB y RGBW con cuatro o cinco cables para usar con controlador y elegir el color exacto en cada momento.



Light fixture with crown shape or ring of led, this light fixture, allows the lighting around the water jet, obtaining a lighting more distributed in the entire parts of the water jet. Made of stainless steel AISI-304, big resistance, cable under order. Led of high performance, Led type "cree" of high potency, big power of lighting. White 27W, RGB and RGBW 45W, IP 68. RGB and RGBW with four or five cables to use with controller and choose the exact color in every moment.



Projecteur en forme d'une couronne ou un anneau de led, ce projecteur permet l'éclairage autour du jet d'eau, en obtenant un éclairage plus distribué également dans toutes les parties du jet d'eau. Fabriqué dans un acier inoxydable AISI-304, de grande résistance, câble sous commande. Led de haut rendement, Led un type "cree" d'une haute puissance, d'un grand pouvoir d'éclairage. Blanc 27W, RGB et RGBW 45W, IP 68. RGB et RGBW avec quatre ou cinq câbles pour user avec contrôleur et pour choisir la couleur exacte dans chaque moment.

LED ALTO RENDIMIENTO / HIGH POWER LED / LED de HAUT REDEMENT

TECHNICAL DATA



Handmade / Fait à la main

AR 111 SPN Special With Niche



TYPE	DESCRIPCION AR111 SPN "CON NICHICO"	DESCRIPTION AR111 SPN "WITH NICHE"	Wattios	Tesion	Temp	Intensidad	Peso	G. Proteccion
			Watts	Voltage	Temp	Intensity (lm)	Weight	P-Grade
WLT 77007SPN	Led Cree Foco Led Cree 15W Blanco Calido WW Int. Con nicho	Light Fixture Cree 15W Warm White WW Spot. With niche	15W	12/24VDC	3000K	900-1000lm	2,9Kg	IP 68
WLT 77008SPN	Led Cree Foco Led Cree 15W Blanco Frio CW Int. Con nicho	Light Fixture Cree 15W Cold White CW Spot. With niche	15W	12/24VDC	5500K	900-1000lm	2,9Kg	IP 68
WLT 77009SPN	Led Cree Foco Led Cree 15W Blanco Calido WW Ext. Con nicho	Light Fixture Cree 15W Warm White WW Flood. With niche	15W	12/24VDC	3000K	900-1000lm	2,9Kg	IP 68
WLT 77010SPN	Led Cree Foco Led Cree 15W Blanco Frio CW Ext. Con nicho	Light Fixture Cree 15W Cold White CW Flood. With niche	15W	12/24VDC	5500K	900-1000lm	2,9Kg	IP 68
WLT 77011SPN	Led Cree Foco Led Cree 18W Blanco Calido WW Int. Con nicho	Light Fixture Cree 18W Warm White WW Spot. With niche	18W	12/24VDC	3000K	1400-1600lm	2,9Kg	IP 68
WLT 77012SPN	Led Cree Foco Led Cree 18W Blanco Frio CW Int. Con nicho	Light Fixture Cree 18W Cold White CW Spot. With niche	18W	12/24VDC	5500K	1400-1600lm	2,9Kg	IP 68
WLT 77013SPN	Led Cree Foco Led Cree 27W Blanco Calido WW Int. Con nicho	Light Fixture Cree 27W Warm White WW Spot. With niche	27W	12/24VDC	3000K	1800-2000lm	2,9Kg	IP 68
WLT 77014SPN	Led Cree Foco Led Cree 27W Blanco Frio CW Int. Con nicho	Light Fixture Cree 27W Cold White CW Spot. With niche	27W	12/24VDC	5500K	1800-2000lm	2,9Kg	IP 68
WLT 7701615SPN	Led Cree Foco Led Cree 15W RGB 3 en 1. Con nicho	Light Fixture Cree 15W RGB 3 in 1. With niche	15W	12/24VDC		800-900lm	2,9Kg	IP 68
WLT 7701718SPN	Led Cree Foco Led Cree 18W RGB 3 en 1. Con nicho	Light Fixture Cree 18W RGB 3 in 1. With niche	18W	12/24VDC		1200-1400lm	2,9Kg	IP 68
WLT 7701827SPN	Led Cree Foco Led Cree 27W RGB 3 en 1. Con nicho	Light Fixture Cree 27W RGB 3 in 1. With niche	27W	12/24VDC		1500-1800lm	2,9Kg	IP 68
WLT 77016154SPN	Led Cree Foco Led Cree 15W RGBW 4 en 1. Con nicho	Light Fixture Cree 15W RGBW 4 in 1. With niche	15W	12/24VDC		1200-1500lm	2,9Kg	IP 68
WLT 77017184SPN	Led Cree Foco Led Cree 18W RGBW 4 en 1. Con nicho	Light Fixture Cree 18W RGBW 4 in 1. With niche	18W	12/24VDC		2000-2300lm	2,9Kg	IP 68
WLT 77018274SPN	Led Cree Foco Led Cree 27W RGBW 4 en 1. Con nicho	Light Fixture Cree 27W RGBW 4 in 1. With niche	27W	12/24VDC		2200-2500lm	2,9Kg	IP 68



Foco de Acero Inoxidable AISI-304, gran resistencia con 5 metros de cable. Con nicho para empotrar. Lampara de Led de alto rendimiento, Led tipo "Cree" de alta potencia 3 en 1 RGB o 4 en 1 RGBW, gran poder de iluminación. Blanco, RGB y



Light Fixture made of Stainless steel AISI-304, big resistance with 5 meters of cable. With Niche for embed. Lamp of Led of high performance, Led type "Cree" high power, big power of lighting, 3 in 1 RGB or 4 in 1 RGBW. White, RGB & RGBW,



Projecteur d'Acier inoxydable AISI-304, une grande résistance, avec 5 mètres de câble. Avec Niche pour embed. Projecteur de Led de haut rendement, Lampe de Led type "Cree" de haute puissance, 3 dans 1 RGB au 4 dans 1 RGBW, de grand pouvoir d'éclairage. Disponible chez le Blanc, RGB et RGBW, Puissances 15, 18 et 27W. IP 68

CONTROL DMX 512 LED / LED CONTROLERS / LED CONTRÔLEURS

TECHNICAL DATA



DMX RGB 512 CONTROLLER



DMX RGBW 512 CONTROLLER



RGB MINI CONTROLLER COMPACT



RGB EXTENDER MODULE





RGBW MINI RF+RC COMPACT



RGBW MINI TOUCH PANEL COMPACT

 *Accesorios para el control total de los focos de Led, Controlador Profesional 600W / 24VDC, Mini Controladores, uso domestico, 432W/24VDC, Módulos de Ampliación de 600W/24VDC y una amplia gama de fuentes de alimentación.*

 *Accessories for the entire control of Led's light, Professional Controller 600W / 24VDC, Mini Controllers, domestic use, 432W / 24VDC, Modules of Enlargement of 600W/24VDC and wide range of Power Supplies.*

 *Les accessoires pour le contrôle entier de la lumière de Led, le Contrôleur Professionnel 600W / 24VDC, les Contrôleurs Mini-, l'utilisation domestique, 432W / 24VDC, les Modules d'Aggrandissement de 600W/24VDC et de large gamme d'Alimentations électriques.*

CONTROL DMX 512 LED / LED CONTROLLERS / LED CONTRÔLEURS

TECHNICAL DATA

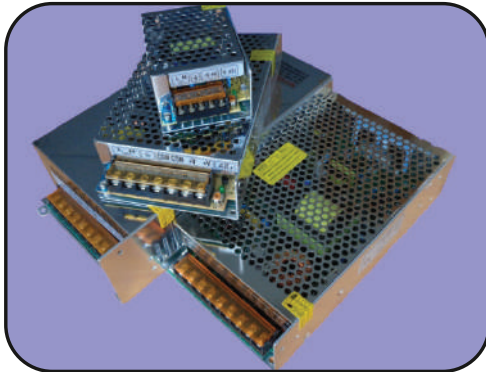

SWITCH POWER SUPPLIERS

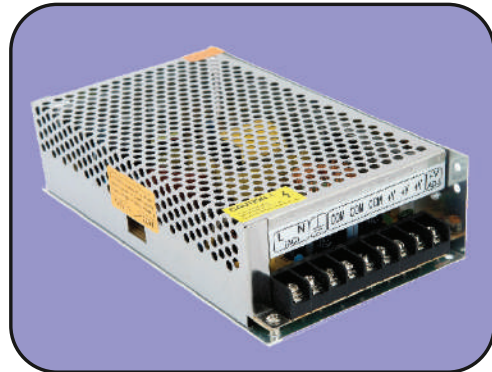

SWITCH POWER SUPPLIERS

1. Connect to low power LED light, take LED RGB module as an example.

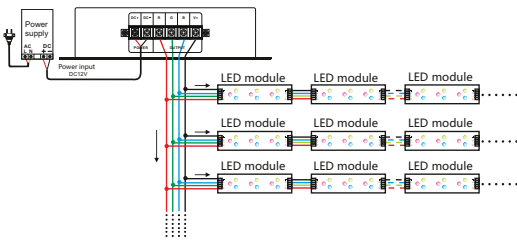

2. If one controller is not enough, can add extra power repeater to expand the power output.

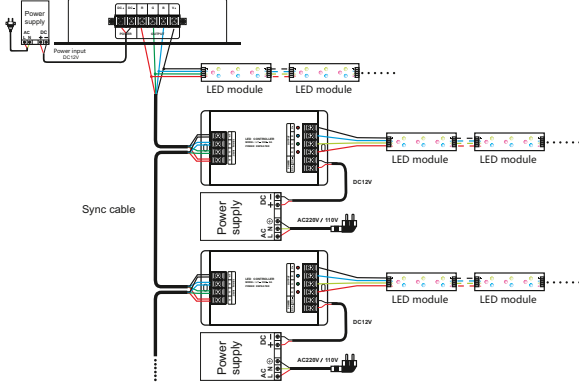

ESQUEMAS DE CONEXIÓN CONNECTION'S SCHEMES LES PLANS DE CONNEXION

3. Connect to the DMX512 device

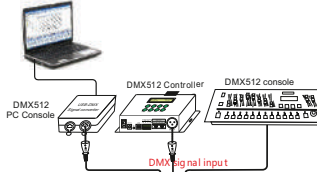

DMX decoder can connect to any brand DMX controller, take the following diagram for example, the connection of DMX computer console, our WLT-800 DMX controller, DMX manual console and DMX decoder. DMX decoder provide 3 DMX signal socket for user to select: XLR-3, RJ45, Green terminal, usage can connect any one socket or mixed use according to their requirement.

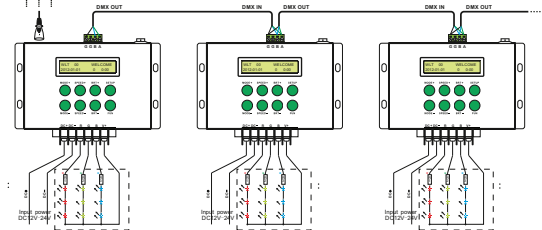

CONTROLADORES Y FUENTES DE ALIMENTACION		CONTROLLERS & POWER SUPPLIERS		Vatios	Tensión	Tensión	Peso
				Watts	Voltage In	Voltage out	Weight
WLT 76000	Fuente de Alimentación 35W, 220V, 12VDC	Power Supplier 35W, 220V, 12VDC		35W	115/220V	12VDC	0,15Kg
WLT 76001	Fuente de Alimentación 150W, 220V, 12VDC	Power Supplier 150W, 220V, 12VDC		150W	115/220V	12VDC	0,70Kg
WLT 76012	Fuente de Alimentación 250W, 220V, 12VDC	Power Supplier 250W, 220V, 12VDC		250W	115/220V	12VDC	1,00Kg
WLT 76002	Fuente de Alimentación 350W, 220V, 12VDC	Power Supplier 350W, 220V, 12VDC		350W	115/220V	12VDC	1,00Kg
WLT 76003	Fuente de Alimentación 500W, 220V, 12VDC	Power Supplier 500W, 220V, 12VDC		500W	115/220V	12VDC	1,80Kg
WLT 76013	Fuente de Alimentación 35W, 220V, 24VDC	Power Supplier 35W, 220V, 24VDC		35W	115/220V	24VDC	0,15kg
WLT 76004	Fuente de Alimentación 150W, 220V, 24VDC	Power Supplier 150W, 220V, 24VDC		150W	115/220V	24VDC	0,70Kg
WLT 76010	Fuente de Alimentación 250W, 220V, 24VDC	Power Supplier 250W, 220V, 24VDC		250W	115/220V	24VDC	1,00Kg
WLT 76005	Fuente de Alimentación 350W, 220V, 24VDC	Power Supplier 350W, 220V, 24VDC		350W	115/220V	24VDC	1,00Kg
WLT 76006	Fuente de Alimentación 500W, 220V, 24VDC	Power Supplier 500W, 220V, 24VDC		500W	115/220V	24VDC	1,80Kg
WLT 76007	Controlador DMX RGB 512	Controller DMX RGB 512		300/600W	12/24VDC	12/24VDC	1,00Kg
WLT 76014	Controlador DMX RGBW 512, With Warm White	Controller DMX RGBW 512, With Warm White		300/600W	12/24VDC	12/24VDC	1,00Kg
WLT 76009	Modulo Ampliacion de Potencia DMX	Power Repeat Module DMX		300/600W	12/24VDC	12/24VDC	0,34kg
WLT 76011	Mini Compacto DMX RGB	Mini Controller DMX RGB		216/432W	12/24VDC	12/24VDC	0,23kg
WLT 76015	Mini Compacto DMX RGBW, Panel Tactil	Mini Controller DMX RGBW, Touch Panel		240/480W	12/24VDC	12/24VDC	0,16kg
WLT 76016	Mini Compacto DMX RGBW, RF+RC	Mini Controller DMX RGBW, RF+RC		240/480W	12/24VDC	12/24VDC	0,20kg

Tobera "S JET" / "S JET" Nozzle / "S JET AJUTAGE"

TECHNICAL DATA

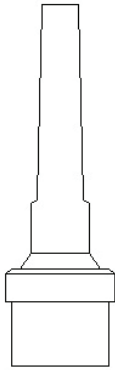

Wind Resistance					
Resistencia al viento					
Noise					
Ruido					
Water Dependent	No / Non				
Dependencia Nivel Agua	No				
Straightener Vane	Yes / Oui				
Centrador Chorro	Si				
Ball Join	Yes / Oui				
Rotula	Si				

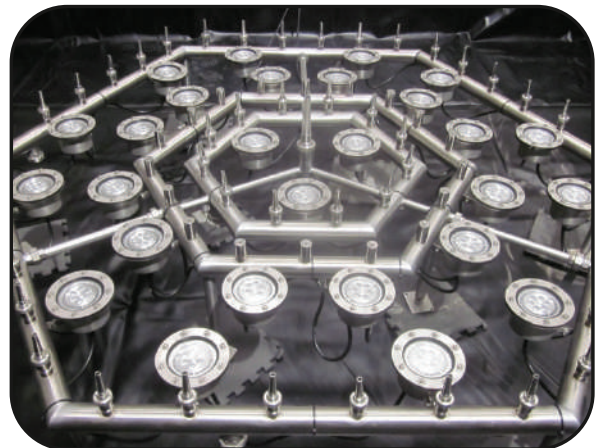

Toberas para fuentes de alta tecnología, fabricadas en Acero inoxidable AISI-304, dotadas con centrador de chorro y así conseguir un chorro fino y estilizado, no son dependientes del nivel del agua.



Nozzles for fountains, high technology, made in Stainless steel AISI-304, provided with straightener vane to obtain a nice and stylized jet, are not dependent of the water level.



Ajutages pour fontaines, haute technologie, fabriquées dans Acier inoxydable AISI-304, dotées avec centralizador du jet et ainsi obtenir un jet fin et stylisé, ne sont pas dépendantes du niveau d'eau.

Tobera "S JET" / "S JET" Nozzle / "S JET AJUTAGE

TECHNICAL DATA

TABLA DE TRABAJO // PERFORMACE TABLE // TABLE DE PERFORMACE

Model	WLT 801205		WLT 803407		WLT 803408		WLT 801008		WLT 801010		WLT 801012		WLT 801512	
Dimen. WxH	25x76 mm		31x99 mm		31x99 mm		37x118 mm		37x118 mm		37x118 mm		54x211 mm	
Millim. Outlet Ø	5 mm		7 mm		8 mm		8 mm		10 mm		12 mm		12 mm	
Connection	G 1/2" F		G 3/4" F		G 3/4" F		G 1" F		G 1" F		G 1" F		G 1 1/2" F	
Material	Stainless Steel		Stainless Steel		Stainless Steel		Stainless Steel		Stainless Steel		Stainless Steel		Stainless Steel	
Weight	0,090 Kg.		0,150 Kg.		0,145 Kg		0,180 Kg		0,175 Kg		0,175 Kg		0,535 Kg.	
Ball Joint	yes / 20° angle		yes / 20° angle		yes / 20° angle		yes / 20° angle		yes / 20° angle		yes / 20° angle		yes / 20° angle	
Water Level	no		no		no		no		no		no		no	
Height / m.	l/min	m.c.w / Bar	l/min	m.c.w / Bar	l/min	m.c.w / Bar	l/min	m.c.w / Bar	l/min	m.c.w / Bar	l/min	m.c.w / Bar	l/min	m.c.w / Bar
0,50	3,9	0,8 / 0,08	5,8	0,5 / 0,05	9,5	0,5 / 0,05	9,5	0,4 / 0,04	15,0	0,7 / 0,07	21	0,6 / 0,06	21	0,5 / 0,05
0,75	5,3	1,0 / 0,10	7,2	0,8 / 0,08	11,5	0,8 / 0,08	11,5	0,7 / 0,07	19,0	1,0 / 0,10	25	0,7 / 0,07	25	0,6 / 0,06
1,00	6,4	1,3 / 0,13	8,2	1,1 / 0,11	12,5	1,1 / 0,11	12,5	1,0 / 0,10	21,0	1,3 / 0,13	32	1,0 / 0,10	32	0,9 / 0,09
1,25	7,3	1,6 / 0,16	9,7	1,4 / 0,14	14,8	1,4 / 0,14	14,8	1,3 / 0,13	25,0	1,7 / 0,17	36	1,4 / 0,14	36	1,3 / 0,13
1,50	8,1	1,9 / 0,19	10,0	1,7 / 0,17	17,1	1,7 / 0,17	17,1	1,6 / 0,16	28,0	1,9 / 0,19	39	1,6 / 0,16	39	1,5 / 0,15
1,75	8,7	2,2 / 0,22	12,1	2,0 / 0,20	18,7	2,0 / 0,20	18,7	1,9 / 0,19	31,0	2,4 / 0,24	43	2,0 / 0,20	43	1,9 / 0,19
2,00	9,3	2,5 / 0,25	13,1	2,4 / 0,24	20,4	2,4 / 0,24	20,4	2,3 / 0,23	33,0	2,7 / 0,27	46	2,2 / 0,22	46	2,1 / 0,21
2,50			14,9	3,0 / 0,30	23,3	3,0 / 0,30	23,3	2,9 / 0,29	37,0	3,4 / 0,34	53	2,8 / 0,28	53	2,7 / 0,27
3,00			16,5	3,8 / 0,38	26,0	3,8 / 0,38	26,0	3,7 / 0,37	41,0	4,2 / 0,42	58	3,4 / 0,34	58	3,3 / 0,33
3,50			19,0	4,6 / 0,46	28,3	4,6 / 0,46	28,3	4,5 / 0,45	45,0	5,1 / 0,51	63	4,1 / 0,41	63	4,0 / 0,40
4,00					30,5	5,4 / 0,54	30,5	5,3 / 0,53	49,0	5,8 / 0,58	68	4,7 / 0,47	68	4,6 / 0,46
5,00							34,9	6,1 / 0,61	55,0	7,6 / 0,76	76	6,0 / 0,60	76	5,9 / 0,59
6,00							39,3	6,9 / 0,69	60,0	9,2 / 0,92	84	7,3 / 0,73	84	7,2 / 0,72
7,00									65,0	10,8 / 1,08	91	8,6 / 0,86	91	8,5 / 0,85
8,00											98	9,8 / 0,98	98	9,7 / 0,97
9,00											105	10,2 / 1,02	105	10,0 / 1,00
10,00													112	11,1 / 1,11

Model	WLT 801514		WLT 801516		WLT 802020		WLT 802520		WLT 802522	
Dimen. WxH	54x211 mm		54x211 mm		65x230 mm		80x360 mm		80x360 mm	
Millim. Outlet Ø	14 mm		16 mm		20 mm		20 mm		22 mm	
Connection	G 1 1/2" F		G 1 1/2" F		G 2" F		G 2 1/2" F		G 2 1/2" F	
Material	Stainless Steel		Stainless Steel		Stainless Steel		Stainless Steel		Stainless Steel	
Weight	0,530 Kg.		0,530 Kg.		0,750 Kg		2,180 Kg		2,180 Kg	
Ball Joint	yes / 20° angle		yes / 20° angle		yes / 20° angle		yes / 20° angle		yes / 20° angle	
Water Level	no		no		no		no		no	
Height / m.	l/min	m.c.w / Bar	l/min	m.c.w / Bar	l/min	m.c.w / Bar	l/min	m.c.w / Bar	l/min	m.c.w / Bar
0,50	30	0,5 / 0,05	35	0,6 / 0,06	58	0,8 / 0,08	58	0,6 / 0,06	74	0,9 / 0,09
0,75	37	0,6 / 0,06	45	0,9 / 0,09	68	1,1 / 0,11	68	0,9 / 0,09	84	1,2 / 0,12
1,00	44	0,9 / 0,09	55	1,1 / 0,11	80	1,3 / 0,13	80	1,1 / 0,11	98	1,4 / 0,14
1,25	50	1,3 / 0,13	62	1,4 / 0,14	88	1,6 / 0,16	88	1,4 / 0,14	107	1,7 / 0,17
1,50	55	1,5 / 0,15	69	1,7 / 0,17	97	1,9 / 0,19	97	1,7 / 0,17	118	2,1 / 0,21
1,75	60	1,9 / 0,19	75	1,9 / 0,19	104	2,1 / 0,21	104	1,9 / 0,19	126	2,3 / 0,23
2,00	65	2,1 / 0,21	82	2,2 / 0,22	113	2,4 / 0,24	113	2,2 / 0,22	137	2,5 / 0,25
2,50	73	2,7 / 0,27	93	2,8 / 0,28	127	3,0 / 0,30	127	2,8 / 0,28	154	3,2 / 0,32
3,00	81	3,3 / 0,33	103	3,4 / 0,34	130	3,6 / 0,36	130	3,4 / 0,34	150	3,8 / 0,38
3,50	87	4,0 / 0,40	112	4,0 / 0,40	151	4,2 / 0,42	151	4,0 / 0,40	183	4,4 / 0,44
4,00	94	4,6 / 0,46	120	4,6 / 0,46	160	4,8 / 0,48	160	4,6 / 0,46	193	4,8 / 0,48
5,00	105	5,9 / 0,59	128	5,2 / 0,52	165	5,4 / 0,54	170	5,2 / 0,52	200	5,4 / 0,54
6,00	116	7,2 / 0,72	136	5,8 / 0,58	170	6,0 / 0,6	181	5,8 / 0,58	208	6,0 / 0,60
7,00	125	8,5 / 0,85	150	7,0 / 0,70	189	7,2 / 0,72	192	7,0 / 0,70	224	7,2 / 0,72
8,00	134	9,7 / 0,97	163	8,2 / 0,82	206	8,4 / 0,84	206	8,2 / 0,82	242	8,4 / 0,84
9,00	143	10,0 / 1,00	175	9,4 / 0,94	221	9,6 / 0,96	221	9,4 / 0,94	260	9,8 / 0,98
10,00	151	11,1 / 1,11	186	10,6 / 1,06	235	10,8 / 1,08	235	10,6 / 1,06	277	11,0 / 1,10
11,00			197	11,8 / 1,18	243	12,0 / 1,20	243	11,8 / 1,18	282	12,3 / 1,23
12,00			207	13,0 / 1,30	251	13,2 / 1,32	251	13,0 / 1,30	291	13,5 / 1,35
13,00					261	14,2 / 1,42	261	14,0 / 1,40	301	14,5 / 1,45
14,00									312	15,5 / 1,55

Tobera Big "S JET" / Big "S JET" Nozzle / Grand "S JET AJUTAGE"

TECHNICAL DATA



Wind Resistance					
Resistencia al viento					
Noise					
Ruido					
Water Dependent	No / Non				
Dependencia Nivel Agua	No				
Straightener Vane	No / Non				
Centrador Chorro	No				
Ball Joint	No / Non				
Rotula	No				



Toberas para fuentes de alta tecnología, fabricadas en Acero inoxidable AISI-304, especiales para grandes alturas, no son dependientes del nivel del agua.



Nozzles for fountains, high technology, made in Stainless steel AISI-304, especial for great high, are not dependent of the water level.



Ajutages pour fontaines, haute technologie, fabriquées dans Acier inoxydable AISI-304, spéciaux pour hauteurs grandes, ne sont pas dépendantes du niveau d'eau.

Tobera Big "S JET" / Big "S JET" Nozzle / Grand "S JET AJUTAGE"

TECHNICAL DATA



TABLA DE TRABAJO // PERFORMANCE TABLE // TABLE DE PERFORMANCE

Model	WLT 803028		WLT 803030		WLT 804035		WLT 805042		WLT 806061	
Dimen. WxH	96x407 mm		96x407 mm		H 600 mm		H 460 mm		H 680 mm	
Millim. Outlet Ø	28 mm		30 mm		35 mm		42 mm		61 mm	
Connection	G 3" F		G 3" F		Flange 4" DN100		Flange 5" DN125		Flange 6" DN150	
Material	Stainless Steel		Stainless Steel		Stainless Steel		Stainless Steel		Stainless Steel	
Weight	2,930 Kg		2,925 Kg		13 Kg		25 Kg		27 Kg	
Ball Joint	yes / 20° angle		yes / 20° angle		no		Adjust flange		no	
Water Level	no		no		no		no		no	
Height / m.	l/min	m.c.w / Bar	l/min	m.c.w / Bar	l/min	m.c.w / Bar	l/min	m.c.w / Bar	l/min	m.c.w / Bar
1,00	184	1,3 / 0,13	204	1,3 / 0,13	215	1,3 / 0,13	414	1,4 / 0,14	953	1,3 / 0,13
2,00	276	2,5 / 0,25	296	2,5 / 0,25	395	2,6 / 0,26	600	2,7 / 0,27	1360	2,6 / 0,26
3,00	337	3,8 / 0,38	357	3,8 / 0,38	515	3,8 / 0,38	740	3,7 / 0,37	1672	3,7 / 0,37
4,00	390	5,0 / 0,50	410	5,0 / 0,50	582	5,1 / 0,51	859	5,0 / 0,50	1935	4,8 / 0,48
5,00	430	6,3 / 0,63	450	6,3 / 0,63	653	6,3 / 0,63	963	6,4 / 0,64	2167	6,2 / 0,62
6,00	487	7,5 / 0,75	507	7,5 / 0,75	717	7,5 / 0,75	1058	7,6 / 0,76	2377	7,5 / 0,75
7,00	520	8,8 / 0,88	540	8,8 / 0,88	777	8,8 / 0,88	1145	8,9 / 0,89	2570	8,8 / 0,88
8,00	550	10,0 / 1,00	570	10,0 / 1,00	832	10,0 / 1,00	1227	11,0 / 1,10	2750	10,0 / 1,00
9,00	565	11,2 / 1,12	585	11,2 / 1,12	883	11,3 / 1,13	1303	11,4 / 1,14	2918	11,2 / 1,12
10,00	610	12,5 / 1,25	630	12,5 / 1,25	932	12,5 / 1,25	1375	12,6 / 1,26	3078	12,5 / 1,25
12,00	670	15,0 / 1,50	690	15,0 / 1,50	1023	15,0 / 1,50	1509	15,1 / 1,51	3374	15,0 / 1,50
14,00	720	17,5 / 1,75	740	17,5 / 1,75	1120	18,0 / 1,80	1650	18,0 / 1,80	3570	18,1 / 1,81
20,00			860	2,5 / 2,50	1327	25,0 / 2,50	1957	25,1 / 2,51	4365	18,6 / 1,86
30,00			1080	37,5 / 3,75	1630	37,6 / 3,76			5353	37,6 / 3,76
40,00			1280	50,0 / 5,00	1885	50,0 / 5,00			6185	50,0 / 5,00
50,00									6919	63,0 / 6,30
60,00									7582	75,0 / 7,50
70,00									8170	87,5 / 8,75
80,00									8760	100,0 / 10,00
100,00									9800	127,0 / 12,70



Toberas para fuentes de alta tecnología, fabricadas en Acero inoxidable AISI-304, especiales para grandes alturas, no son dependientes del nivel del agua.



Nozzles for fountains, high technology, made in Stainless steel AISI-304, especial for great high, are not dependent of the water level.



Ajutages pour fontaines, haute technologie, fabriquées dans Acier inoxydable AISI-304, spéciaux pour hauteurs grandes, ne sont pas dépendantes du niveau d'eau.



Tobera "CASCADA" / "CASCADE" Nozzle / Ajutage "JET de CASCADE"

"Con Rotula" / "With Ball Joint" / "Avec Boule"

TECHNICAL DATA



Model	WLT 701010		WLT 701515		WLT 702016		WLT 703025	
Dimen. WxH	61x140 mm		87x188 mm		97x215 mm		145x330 mm	
Millim. Outlet Ø	48 mm		68 mm		75 mm		122 mm	
Connection	G 1" F		G 1 1/2" F		G 2" F		G 3" F	
Material	Stainless Steel		Stainless Steel		Stainless Steel		Stainless Steel	
Weight	0,470 Kg.		0,875 Kg.		1,285 Kg		4,155 Kg	
Ball Joint	yes		yes		yes		yes	
Water Level	15 mm		25 mm		30 mm		30 mm	
Height / m.	l/min	m.c.w / Bar	l/min	m.c.w / Bar	l/min	m.c.w / Bar	l/min	m.c.w / Bar
0,25	29	1,2 / 0,18						
0,50	35	2,6 / 0,26	80	2,9 / 0,29	123	2,5 / 0,25		
0,75	40	3,3 / 0,33	89	3,5 / 0,35	143	3,0 / 0,30		
1,00	44	4,1 / 0,41	98	4,2 / 0,42	159	3,5 / 0,35	369	3,5 / 0,35
1,50	52	5,7 / 0,57	113	5,5 / 0,55	187	4,7 / 0,47	427	4,7 / 0,47
2,00	59	7,3 / 0,73	126	6,8 / 0,68	210	6,0 / 0,60	478	5,9 / 0,59
2,50	70	10,4 / 1,04	138	8,1 / 0,81	230	7,3 / 0,73	524	7,1 / 0,71
3,00	75	12,0 / 1,20	150	10,0 / 1,00	251	8,5 / 0,85	567	8,4 / 0,84
4,00	80	13,6 / 1,36	169	12,2 / 1,22	287	11,0 / 1,10	644	10,8 / 1,08
5,00	89	16,8 / 1,68	186	14,6 / 1,46	317	13,5 / 1,35	713	13,6 / 1,36
6,00			204	17,5 / 1,75	354	16,2 / 1,62	776	15,7 / 1,57
7,00			220	20,0 / 2,00	372	19,0 / 1,90	835	18,0 / 1,80
8,00					400	21,5 / 2,15	880	20,6 / 2,06
10,00					450	26,8 / 2,68	990	25,4 / 2,54
12,00							1084	30,5 / 3,05
14,00							1170	35,0 / 3,50
16,00							1250	40,0 / 4,00
18,00							1326	45,0 / 4,50
20,00							1400	50,0 / 5,00

Wind Resistance				
Resistencia al viento				
Noise				
Ruido				
Water Dependent	Yes / Oui			
Dependencia Nivel Agua	Si			
Straightener Vane	No / Non			
Centrador Chorro	No			
Ball Join	Yes / Oui			
Rotula	Si			

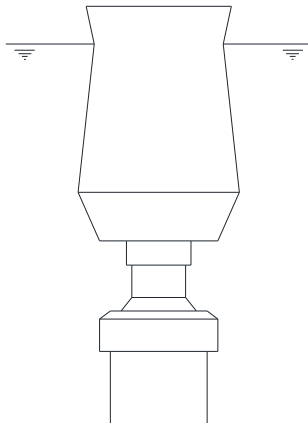

Toberas para fuentes de alta tecnología, fabricadas en Acero inoxidable AISI-304, dependientes del nivel del agua.



Nozzles for fountains, high technology, made in Stainless steel AISI-304, especial for great high, water level dependent.



Ajutages pour fontaines, haute technologie, fabriquées dans Acier inoxydable AISI-304, dépendantes du niveau d'eau.



Tobera "Agua Nieve" / "Snowy Foam" Nozzle / Ajutage "Mousse de Neige"

TECHNICAL DATA



Model	WLT 710595		WLT 713496		WLT 711097		WLT 711598	
Dimen. WxH	37x105 mm		43x160 mm		46x185 mm		55x195 mm	
Millim. Outlet Ø	20 mm		24 mm		30 mm		35 mm	
Connection	G 1/2" F		G 3/4" F		G 1" F		G 1 1/2" F	
Material	Stainless Steel		Stainless Steel		Stainless Steel		Stainless Steel	
Weight	0,285 Kg.		0,420 Kg.		0,570 Kg		0,690 Kg	
Ball Joint	yes		yes		yes		yes	
Water Level	no		no		no		no	
Height / m.	l/min	m.c.w / Bar	l/min	m.c.w / Bar	l/min	m.c.w / Bar	l/min	m.c.w / Bar
0,25	30	0,8 / 0,08	36	0,9 / 0,09	45	1,0 / 0,10	53	1,1 / 0,11
0,50	38	1,2 / 0,12	44	1,3 / 0,13	52	1,5 / 0,15	69	1,6 / 0,16
0,75	54	1,9 / 0,19	60	2,0 / 0,20	69	2,2 / 0,22	89	2,3 / 0,23
1,00	63	2,4 / 0,24	69	2,5 / 0,25	76	2,7 / 0,27	101	2,8 / 0,28
1,25	71	3,1 / 0,31	77	3,2 / 0,32	86	3,5 / 0,35	112	3,6 / 0,36
1,50	79	3,6 / 0,36	84	3,7 / 0,37	97	4,0 / 0,40	121	4,1 / 0,41
1,75	87	4,3 / 0,43	91	4,4 / 0,44	100	4,6 / 0,46	130	4,7 / 0,47
2,00	97	4,8 / 0,48	103	4,9 / 0,49	109	5,2 / 0,52	139	5,4 / 0,54
2,50			110	6,2 / 0,62	121	6,5 / 0,65	154	6,6 / 0,66
3,00					130	7,5 / 0,75	165	7,6 / 0,76
3,50							182	8,6 / 0,86

Wind Resistance					
Resistencia al viento					
Noise					
Ruido					
Water Dependent	No / Non				
Dependencia Nivel Agua	No				
Straightener Vane	Yes / Oui				
Centrador Chorro	Si				
Ball Join	Yes / Oui				
Rotula	Si				



* Pueden ser ensambladas en los módulos Ciber@Kits, para control mediante protocolo DMX
 * Can be assembled in the modules Cyber@Kits, to control DMX protocol.
 * Peuvent être assemblées dans les modules Cyber@Kits, pour contrôle DMX protocole



Toberas para fuentes de alta tecnología, fabricadas en Acero inoxidable AISI-304, dotadas con centrador de chorro y así conseguir un chorro fino y estilizado, no son dependientes del nivel del agua.



Nozzles for fountains, high technology, made in Stainless steel AISI-304, provided with straightener vane to obtain a nice and stylized jet, are not dependent of the water level.



Ajutages pour fontaines, haute technologie, fabriquées dans Acier inoxydable AISI-304, dotées avec centralizador du jet et ainsi obtenir un jet fin et stylisé, ne sont pas dépendantes du niveau d'eau.



Tobera "Agua Nieve" / "Snowy Foam" Nozzle / Ajutage "Mousse de Neige"

TECHNICAL DATA



Wind Resistance	
Resistencia al viento	
Noise	
Ruido	
Water Dependent	No / Non
Dependencia Nivel Agua	No
Straightener Vane	Yes / Oui
Centrador Chorro	Si
Ball Joint	No / Non
Rotula	No



Model	WLT 711091		WLT 711092		WLT 711502	
Dimen. WxH	60x160 mm		60x160 mm		81x182 mm	
Millim. Outlet Ø	32 mm		32 mm		50 mm	
Connection	G 1" F		G 1" F		G 1 1/2" F	
Material	Stainless Steel		S. Steel / PP+FV		Stainless Steel	
Weight	0,970 Kg		0,450 Kg		1,400 Kg	
Ball Joint	no		no		no	
Water Level	no		no		no	
Height / m.	l/min	m.c.w / Bar	l/min	m.c.w / Bar	l/min	m.c.w / Bar
0,25	44	1,0 / 0,10	44	1,0 / 0,10	46	1,0 / 0,10
0,50	50	1,5 / 0,15	50	1,5 / 0,15	82	1,5 / 0,15
0,75	68	2,2 / 0,22	68	2,2 / 0,22	100	2,2 / 0,22
1,00	75	2,7 / 0,27	75	2,7 / 0,27	115	2,6 / 0,26
1,25	84	3,5 / 0,35	84	3,5 / 0,35	130	3,1 / 0,31
1,50	96	4,0 / 0,40	96	4,0 / 0,40	143	3,9 / 0,39
1,75	98	4,6 / 0,46	98	4,6 / 0,46	151	4,6 / 0,46
2,00	107	5,2 / 0,52	107	5,2 / 0,52	166	5,2 / 0,52
2,50	118	6,5 / 0,65	118	6,5 / 0,65	185	6,5 / 0,65
3,00	127	7,5 / 0,75	127	7,5 / 0,75	203	7,5 / 0,75
4,00					240	10,2 / 1,02
5,00					268	12,7 / 1,27
6,00					297	15,4 / 1,54

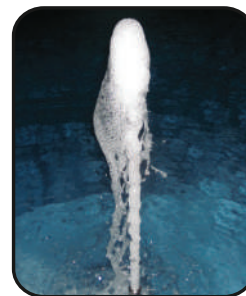

* Pueden ser ensambladas en los módulos Cyber@Kits, para control mediante protocolo DMX
 * Can be assembled in the modules Cyber@Kits, to control DMX protocol.
 * Peuvent être assemblées dans les modules Cyber@Kits, pour contrôle DMX protocole



Toberas para fuentes de alta tecnología, fabricadas en Acero inoxidable AISI-304, dotadas con centrador de chorro y así conseguir un chorro fino y estilizado, no son dependientes del nivel del agua.



Nozzles for fountains, high technology, made in Stainless steel AISI-304, provided with straightener vane to obtain a nice and stylized jet, are not dependent of the water level.



Ajutages pour fontaines, haute technologie, fabriquées dans Acier inoxydable AISI-304, dotées avec centralizador du jet et ainsi obtenir un jet fin et stylisé, ne sont pas dépendantes du niveau d'eau..



Tobera "FOAM GEISER" / "FOAM GEYSER" Nozzle / Ajutage "JET de GEISER"

TECHNICAL DATA



Model	WLT 711089		WLT 711580		WLT 712081	
Dimen. WxH	44x162 mm		52x222 mm		73x229 mm	
Millim. Outlet Ø	10 mm		14 mm		15 mm	
Connection	G 1" F		G 1 1/2" F		G 2" F	
Material	Stainless Steel		Stainless Steel		Stainless Steel	
Weight	0,330 Kg.		0,850 Kg		0,975 Kg	
Ball Joint	yes		yes		yes	
Water Level	40 mm		45 mm		50mm	
Height / m.	l/min	m.c.w / Bar	l/min	m.c.w / Bar	l/min	m.c.w / Bar
0,50	8,0	3,80 / 0,38	8,5	2,90 / 0,29	18	2,90 / 0,29
1,00	10,0	7,40 / 0,74	17,0	5,70 / 0,57	25	3,90 / 0,39
1,50	14,0	10,40 / 1,04	21,0	7,90 / 0,79	29	6,10 / 0,61
2,00	16,0	13,70 / 1,37	25,0	10,20 / 1,02	34	7,80 / 0,78
2,50	17,5	17,20 / 1,72	27,0	12,00 / 1,20	37	9,50 / 0,95
3,00	21,0	20,5 / 2,05	31,0	14,30 / 1,40	41	11,00 / 1,10

Wind Resistance					
Resistencia al viento					
Noise					
Ruido					
Water Dependent	Yes / Oui				
Dependencia Nivel Agua	si				
Straightener Vane	Yes / Oui				
Centrador Chorro	Si				
Ball Join	Yes / Oui				
Rotula	Si				

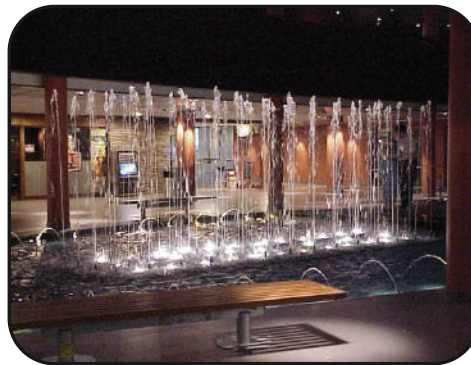
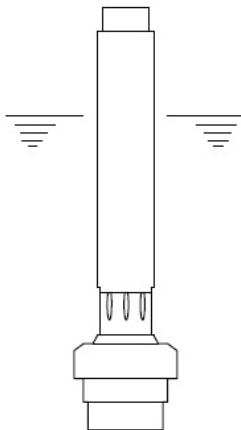

Toberas para fuentes de alta tecnología, fabricadas en Acero inoxidable AISI-304, dependientes del nivel del agua.



Nozzles for fountains, high technology, made in Stainless steel AISI-304, water level dependent.



Ajutages pour fontaines, haute technologie, fabriquées dans Acier inoxydable AISI-304, dépendantes du niveau d'eau.



Tobera "COLUMN ANCHA" / "WIDE COLUMN STREAM" Nozzle / Ajutage "LARGE COLONNE"

TECHNICAL DATA



Model	WLT 711083		WLT 711584		WLT 712085	
Dimen. WxH	38x154 mm		61x205 mm		73x228 mm	
Millim. Outlet Ø	31 mm		31 mm		40 mm	
Connection	G 1" F		G 1 1/2" F		G 2" F	
Material	Stainless Steel		Stainless Steel		Stainless Steel	
Weight	0,365 Kg		0,950 Kg		1,405 Kg	
Ball Joint	yes		yes		yes	
Water Level	no		no		no	
Height / m.	l/min	m.c.w / Bar	l/min	m.c.w / Bar	l/min	m.c.w / Bar
1,00	204	1,2 / 0,12	204	1,3 / 0,13	350	1,4 / 0,14
2,00	296	2,4 / 0,24	296	2,5 / 0,25	550	2,7 / 0,27
3,00	357	3,6 / 0,36	357	3,8 / 0,38	630	4,0 / 0,40
4,00	410	4,9 / 0,49	410	5,0 / 0,50	727	5,3 / 0,53
5,00	460	6,0 / 0,60	460	6,3 / 0,63	810	6,5 / 0,65
6,00	507	7,2 / 0,72	507	7,5 / 0,75	876	7,7 / 0,77
7,00	540	8,4 / 0,84	540	8,8 / 0,88	957	9,0 / 0,90
8,00	577	9,60 / 0,96	577	10,0 / 1,00	1000	10,5 / 1,05
9,00	600	10,8 / 1,08	600	11,2 / 1,12	1034	11,5 / 1,15
10,00	640	12,0 / 1,20	640	12,5 / 1,25	1100	12,8 / 1,28
12,00	710	14,4 / 1,44	710	15,0 / 1,50	1240	15,5 / 1,55
14,00	768	16,8 / 1,68	768	17,5 / 1,75	1350	18,5 / 1,85
20,00			910	25,5 / 2,50	1620	25,5 / 2,55
30,00			1110	37,5 / 3,75	1990	38,6 / 3,86
40,00			1280	50,0 / 5,00	2225	50,0 / 5,00
50,00					2570	60,0 / 6,00

Wind Resistance					
Resistencia al viento					
Noise					
Ruido					
Water Dependent	No / Non				
Dependencia Nivel Agua	No				
Straightener Vane	Yes / Oui				
Centrador Chorro	Si				
Ball Join	Yes / Oui				
Rotula	Si				

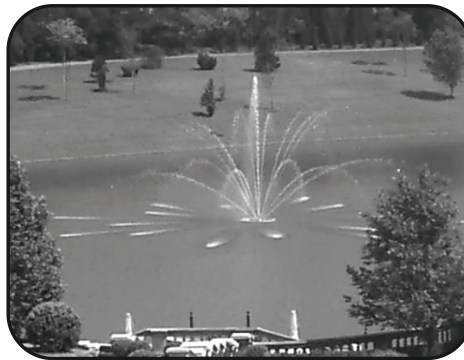
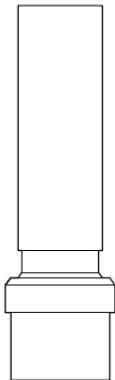

Toberas para fuentes de alta tecnología, fabricadas en Acero inoxidable AISI-304, no dependientes del nivel del agua.



Nozzles for fountains, high technology, made in Stainless steel AISI-304, not water level dependent.



Ajutages pour fontaines, haute technologie, fabriquées dans Acier inoxydable AISI-304, ne sont pas dépendantes du niveau d'eau.



Tobera "COLUMNNA FINA" / "THIN COLUMN STREAM" Nozzle / Ajutage "FINE COLONNE"

TECHNICAL DATA



Model	WLT 711183		WLT 711684	
Dimen. WxH	45x180 mm		60x222 mm	
Millim. Outlet Ø	13 mm		18 mm	
Connection	G 1" M		G 1 1/2" M	
Material	Stainless Steel		Stainless Steel	
Weight	0,290 Kg.		0,510 Kg	
Ball Joint	yes		yes	
Water Level	no		no	
Height / m.	l/min	m.c.w / Bar	l/min	m.c.w / Bar
0,50	23	0,4 / 0,04	54	0,7 / 0,07
0,75	30	0,5 / 0,05	64	1,0 / 0,10
1,00	37	0,8 / 0,08	76	1,2 / 0,12
1,25	43	1,2 / 0,12	84	1,5 / 0,15
1,50	48	1,4 / 0,14	93	1,8 / 0,18
1,75	53	1,8 / 0,18	100	2,0 / 0,20
2,00	58	2,0 / 0,20	109	2,3 / 0,23
2,50	66	2,6 / 0,26	123	2,9 / 0,29
3,00	74	3,4 / 0,34	127	3,5 / 0,35
3,50	80	3,9 / 0,39	147	4,1 / 0,41
4,00	87	4,5 / 0,45	156	4,7 / 0,47
5,00	98	5,8 / 0,58	161	5,3 / 0,53
6,00	109	7,1 / 0,71	166	6,0 / 0,60
7,00	118	8,6 / 0,86	185	7,1 / 0,71
8,00	127	9,6 / 0,96	200	8,3 / 0,83
9,00	136	10,0 / 1,00	218	9,7 / 0,97
10,00	144	11,0 / 1,10	230	10,7 / 1,07
11,00	153	11,4 / 1,14	239	12,0 / 1,20
12,00	162	11,9 / 1,19	247	13,2 / 1,32
13,00			255	14,2 / 1,42



Wind Resistance	■	■	■	■	■
Resistencia al viento	■	■	■	■	■
Noise	■	■	■	■	■
Ruido	■	■	■	■	■
Water Dependent	No / Non				
Dependencia Nivel Agua	No				
Straightener Vane	Yes / Oui				
Centrador Chorro	Si				
Ball Join	Yes / Oui				
Rotula	Si				

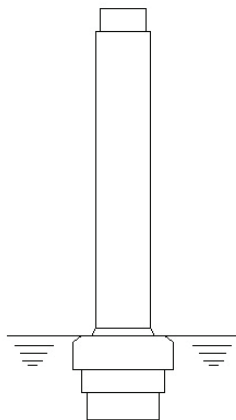

Toberas para fuentes de alta tecnología, fabricadas en Acero inoxidable AISI-304, no dependientes del nivel del agua.



Nozzles for fountains, high technology, made in Stainless steel AISI-304, not water level dependent.



Ajutages pour fontaines, haute technologie, fabriquées dans Acier inoxydable AISI-304, ne sont pas dépendantes du niveau d'eau.

Tobera "BORBOTON ESPUMOSO" / "SNOWY FIR BUBBLING" Nozzle / Ajutage "ENNEIGÉ SAPIN"

TECHNICAL DATA



Model	WLT 713447		WLT 711048		WLT 711549		WLT 712040	
Dimen. WxH	32x210 mm		36x230 mm		52x275 mm		64x305 mm	
Millim. Outlet Ø	23 mm		27 mm		41 mm		51 mm	
Connection	G 3/4" F		G 1" F		G 1 1/2" F		G 2" F	
Material	Stainless Steel		Stainless Steel		Stainless Steel		Stainless Steel	
Weight	0,175 Kg.		0,240 Kg.		0,440 Kg		0,785 Kg	
Ball Joint	no		no		no		no	
Water Level	yes / 80 mm		yes / 100 mm		yes / 120 mm		yes / 130 mm	
Height / m.	l/min	m.c.w / Bar	l/min	m.c.w / Bar	l/min	m.c.w / Bar	l/min	m.c.w / Bar
0,50	23	6,5 / 0,65	83	7,50 / 0,75	117	9,0 / 0,90	140	8,0 / 0,80
0,75	26	8,0 / 0,80	92	11,30 / 1,13	146	14,5 / 1,45	172	13,0 / 1,30
1,00	30	9,5 / 0,95	100	14,70 / 1,47	171	19,0 / 1,90	198	17,0 / 1,70
1,50	34	11,8 / 1,18	114	19,7 / 1,97	208	24,5 / 2,45	230	24,5 / 2,45
2,00			127	25,5 / 2,55	226	32,0 / 3,20	252	31,0 / 3,10
2,50			136	30,0 / 3,00	238	37,5 / 3,75	267	36,5 / 3,65
3,00					249	42,5 / 4,25	282	43,6 / 4,36
4,00							302	52,7 / 5,27

Wind Resistance				
Resistencia al viento				
Noise				
Ruido				
Water Dependent	Yes / Oui			
Dependencia Nivel Agua	Si			
Straightener Vane	No / Non			
Centrador Chorro	No			
Ball Join	No / Non			
Rotula	No			

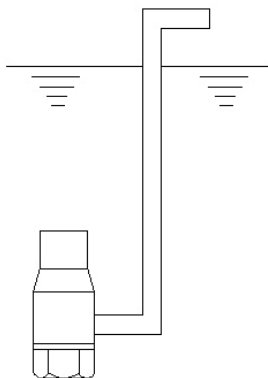

Toberas para fuentes de alta tecnología, fabricadas en Acero inoxidable AISI-304, son dependientes del nivel del agua.



Nozzles for fountains, high technology, made in Stainless steel AISI-304, water level dependent.



Ajutages pour fontaines, haute technologie, fabriquées dans Acier inoxydable AISI-304, dépendantes du niveau d'eau.



Tobera "ESFERA DE AGUA" / "WATER SPHERE" Nozzle / Ajutage "SPHÈRES D'EAU"

TECHNICAL DATA

Diferentes medidas "bajo pedido" / Different Sizes "Under Request" / Différentes mesures "sous commande"

En Acero inoxidable o Latón / Made in Stainless Steel or Brass / Dans l'Acier inoxydable ou le Laiton

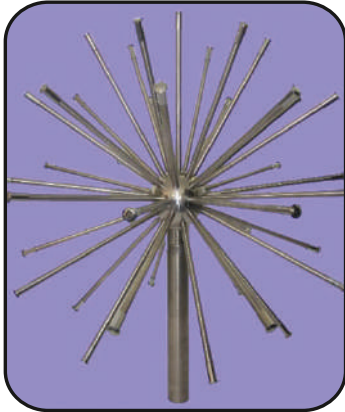

Model	ESFERAS / SPHERES / SPHÈRE							
	WLT 711090		WLT 711592		WLT 712093		WLT 713094	
Dimen. WxH	1200x2400 mm		1800x3000 mm		1800x3000 mm		2000x3800 mm	
No. Arms	88		121		121		121	
Connection	G 1 1/2" F		G 2" F		G 2 1/2" F		G 3" F	
Material	Brass or Stainless Steel		Brass or Stainless Steel		Brass or Stainless Steel		Brass or Stainless Steel	
Weight	10 Kg.		15 Kg.		25 Kg		45 Kg	
Pool Size Ø	1600 mm		3300 mm		4200 mm		6000 mm	
Water Level	no		no		no		no	
	l/min	m.c.w / Bar	l/min	m.c.w / Bar	l/min	m.c.w / Bar	l/min	m.c.w / Bar
	310	1,50 / 0,15	410	2,00 / 0,20	800	2,20 / 0,22	1050	2,90 / 0,29

Distintas medidas, preguntar // Different sizes on request // Des mesures distinctes, demander

Wind Resistance				
Resistencia al viento				
Noise				
Ruido				
Water Dependent	No / Non			
Dependencia Nivel Agua	No			
Straightener Vane	No / Non			
Centrador Chorro	No			
Ball Joint	No / Non			
Rotula	No			

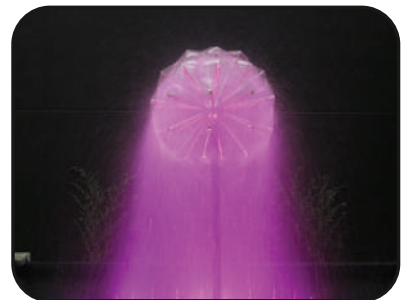
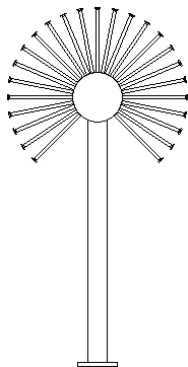

Toberas para fuentes de alta tecnología, fabricadas en Acero inoxidable AISI-304, no son dependientes del nivel del agua.



Nozzles for fountains, high technology, made in Stainless steel AISI-304, not water level dependent.



Ajutages pour fontaines, haute technologie, fabriquées dans Acier inoxydable AISI-304, ne sont pas dépendantes du niveau d'eau.



Tobera "SEMI-ESFERA DE AGUA" / "WATER HEMI-SPHERE" Nozzle / Ajutage "SEMI-SPHÈRES D'EAU"

TECHNICAL DATA

Diferentes medidas "bajo pedido" / Different Sizes "Under Request" / Différentes mesures "sous commande"
 En Acero inoxidable o Latón / Made in Stainless Steel or Brass / Dans l'Acier inoxydable ou le Laiton

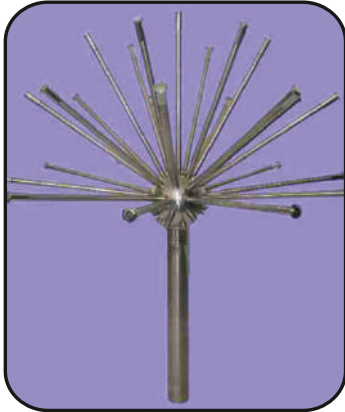

SEMIESFERAS / SEMISPHERES / SEMISPHERE								
Model	WLT 711095		WLT 711596		WLT 712097		WLT 712598	
Dimen. WxH	1200x1600 mm		1800x1650 mm		1800x1650 mm		2000x1700 mm	
No. Arms	49		74		74		74	
Connection	G 1" F		G 1 1/2" F		G 2" F		G 3" F	
Material	Brass or Stainless Steel		Brass or Stainless Steel		Brass or Stainless Steel		Brass or Stainless Steel	
Weight	10 Kg.		15 Kg.		25 Kg		45 Kg	
Pool Size Ø	1600 mm		3300 mm		4200 mm		6000 mm	
Water Level	no		no		no		no	
	l/min	m.c.w / Bar	l/min	m.c.w / Bar	l/min	m.c.w / Bar	l/min	m.c.w / Bar
	210	1,50 / 0,15	310	2,00 / 0,20	550	2,20 / 0,22	850	2,90 / 0,29

Wind Resistance				
Resistencia al viento				
Noise				
Ruido				
Water Dependent	No / Non			
Dependencia Nivel Agua	No			
Straightener Vane	No / Non			
Centrador Chorro	No			
Ball Joint	No / Non			
Rotula	No			

Distintas medidas, preguntar // Different sizes on request // Des mesures distinctes, demander

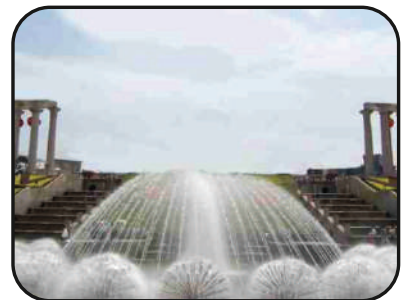
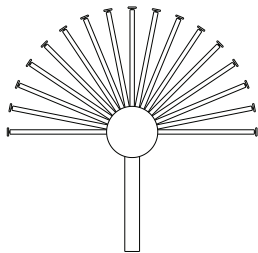

Toberas para fuentes de alta tecnología, fabricadas en Acero inoxidable AISI-304, no son dependientes del nivel del agua.



Nozzles for fountains, high technology, made in Stainless steel AISI-304, not water level dependent.



Ajutages pour fontaines, haute technologie, fabriquées dans Acier inoxydable AISI-304, ne sont pas dépendantes du niveau d'eau.

Tobera "PULVERIZACIÓN" / "SPRAYING FOG JET" Nozzle / Ajutage "PULVÉRISATION"

TECHNICAL DATA



Model	WLT 710571		WLT 713472		WLT 711073		WLT 711574	
Dimen. WxH	24x27 mm		30x44 mm		37x47 mm		52x67 mm	
Millim. Outlet Ø	4 mm		6 mm		7 mm		8 mm	
Connection	G 1/2" F		G 3/4" F		G 1" F		G 1/2 2" F	
Material	Stainless Steel		Stainless Steel		Stainless Steel		Stainless Steel	
Weight	0,070 Kg.		0,120 Kg.		0,175 Kg		0,400 Kg	
Ball Joint	no		no		no		no	
Water Level	no		no		no		no	
Height / m.	l/min	m.c.w / Bar	l/min	m.c.w / Bar	l/min	m.c.w / Bar	l/min	m.c.w / Bar
0,50	2,5	2,30 / 0,23	2,8	2,90 / 0,29	8,4	3,00 / 0,30	9,4	3,50 / 0,35
1,00	4,3	4,00 / 0,40	5,5	4,80 / 0,48	13,6	5,00 / 0,50	12,0	6,80 / 0,68
1,50	6,1	6,50 / 0,65	7,2	6,70 / 0,67	17,0	7,00 / 0,70	14,4	9,00 / 0,90
2,00	8,1	11,00 / 1,10	9,3	8,70 / 0,87	20,0	9,00 / 0,90	15,7	11,50 / 1,50
2,50	9,0	11,50 / 1,15	9,9	11,00 / 1,10	22,0	12,00 / 1,20	20,1	12,80 / 1,28
3,00							24,1	14,20 / 1,40

Wind Resistance					
Resistencia al viento					
Noise					
Ruido					
Water Dependent	No / Non				
Dependencia Nivel Agua	No				
Straightener Vane	No / Non				
Centrador Chorro	No				
Ball Join	No / Non				
Rotula	No				

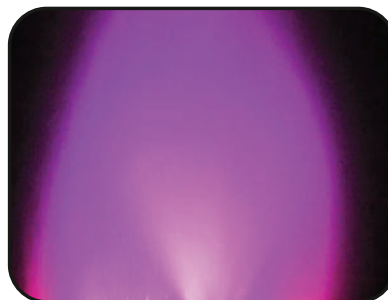
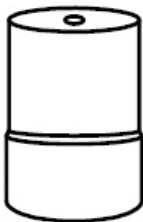

Toberas para fuentes de alta tecnología, fabricadas en Acero inoxidable AISI-304, no son dependientes del nivel del agua.



Nozzles for fountains, high technology, made in Stainless steel AISI-304, not water level dependent.



Ajutages pour fontaines, haute technologie, fabriquées dans Acier inoxydable AISI-304, ne sont pas dépendantes du niveau d'eau.

Tobera "VOLCANO" / "VOLCANO" Nozzle / Ajutage "VOLCANO"

TECHNICAL DATA



Tobera "MINI VOLCANO" / "VOLCANO MINI" Nozzle / Ajutage "VOLCANO MINI"

Model	WLT 711058			WLT 711559			WLT 712050		
Dimen. WxH	74x112 mm			81x114 mm			87x124 mm		
Millim. Outlet Ø	1x6Ø + 6x5Ø + 12x6Ø			1x7Ø + 6x5Ø + 12x6Ø			1x8Ø + 8x5Ø + 12x6Ø		
Connection	G 1" F			G 1 1/2" F			G 2" F		
Material	Stainless Steel			Stainless Steel			Stainless Steel		
Weight	0,400 Kg.			0,610 Kg.			0,790 Kg		
Ball Joint	no			no			no		
Water Level	no			no			no		
Height / m.	l/min	m.c.w / Bar		l/min	m.c.w / Bar		l/min	m.c.w / Bar	
0,50	85,2	0,8 / 0,08		86,2	0,8 / 0,08		93,8	0,8 / 0,08	
0,75	113,4	1,1 / 0,11		113,4	1,1 / 0,11		124,0	1,1 / 0,11	
1,00	132,4	1,6 / 0,16		132,4	1,6 / 0,16		145,0	1,6 / 0,16	
1,25	156,3	1,7 / 0,17		156,3	1,7 / 0,17		170,7	1,7 / 0,17	
1,50	176,8	1,9 / 0,19		176,8	1,9 / 0,19		192,8	1,9 / 0,19	
1,75	201,1	2,0 / 0,20		201,1	2,0 / 0,20		219,7	2,0 / 0,20	
2,00	218,3	2,4 / 0,24		158,3	2,4 / 0,24		238,3	2,4 / 0,24	
2,50				181,7	3,2 / 0,32		268,1	3,2 / 0,32	
3,00				203,7	3,9 / 0,39		296,5	3,9 / 0,39	
3,50							327,8	4,7 / 0,47	
4,00							359,8	5,4 / 0,54	



Tobera "VOLCANO" / "VOLCANO" Nozzle / Ajutage "VOLCANO"

Model	WLT 711562		WLT 712063		WLT 712564		WLT 713065	
Dimen. WxH	125x196 mm		125x196 mm		156x252 mm		210x379 mm	
Millim. Outlet Ø	1x8+6x5 mm		1x8+6x5 mm		1x10+7x8 mm		1x14+9x8 mm	
Connection	G 1 1/2" F		G 2" F		G 2 1/2" F		G 3" F	
Material	Stainless Steel		Stainless Steel		Stainless Steel		Stainless Steel	
Weight	1,625 Kg.		1,635 Kg.		2,985 Kg		5,035 Kg	
Ball Joint	no		no		no		no	
Water Level	no		no		no		no	
Height / m.	l/min	m.c.w / Bar	l/min	m.c.w / Bar	l/min	m.c.w / Bar	l/min	m.c.w / Bar
0,50	32,9	0,8 / 0,08	32,9	0,7 / 0,07	81,5	0,7 / 0,07	115,5	0,5 / 0,05
0,75	43,3	1,0 / 0,10	43,3	0,9 / 0,09	99,5	1,0 / 0,10	140,5	0,8 / 0,08
1,00	50,9	1,3 / 0,13	50,9	1,2 / 0,12	108,5	1,3 / 0,13	156,5	1,1 / 0,11
1,25	58,6	1,6 / 0,16	58,6	1,5 / 0,15	128,6	1,7 / 0,17	183,2	1,4 / 0,14
1,50	65,7	1,9 / 0,19	65,7	1,8 / 0,18	147,7	1,9 / 0,19	208,9	1,7 / 0,17
0,75	70,9	2,2 / 0,22	70,9	2,1 / 0,21	161,9	2,4 / 0,24	228,3	2,0 / 0,20
2,00	76,2	2,5 / 0,25	76,2	2,4 / 0,24	175,8	2,7 / 0,27	248,6	2,4 / 0,24
2,50	82,7	2,8 / 0,28	82,7	2,8 / 0,28	200,1	3,4 / 0,34	282,7	3,0 / 0,30
3,00					223,0	4,2 / 0,42	315,0	3,8 / 0,38
3,50					243,1	5,1 / 0,51	341,7	4,6 / 0,46
4,00					262,5	5,8 / 0,58	368,5	5,4 / 0,54
5,00					289,5	7,6 / 0,76	406,5	6,2 / 0,62
6,00					315,5	9,2 / 0,92	444,5	7,0 / 0,70
7,00					338,7	10,8 / 1,08	476,9	7,9 / 0,79
8,00							525,5	8,8 / 0,88



Toberas para fuentes de alta tecnología, fabricadas en Acero inoxidable AISI-304, no son dependientes del nivel del agua.



Nozzles for fountains, high technology, made in Stainless steel AISI-304, not water level dependent.



Ajutages pour fontaines, haute technologie, fabriquées dans Acier inoxydable AISI-304, ne sont pas dépendantes du niveau d'eau.

Tobera "CORONA" / "CROWN" Nozzle / Ajutage "COURONNE"

TECHNICAL DATA



Tobera "CORONA" / "CROWN" Nozzle / Ajutage "COURONNE"



Model	WLT 711099			WLT 711590	
Dimen. WxH	114x145 mm			114x145 mm	
Millim. Outlet Ø	1x4+6x4+12x4 mm			1x4+6x4+12x4 mm	
Connection	G 1" F			G 1 1/2" F	
Material	Stainless Steel			Stainless Steel	
Weight	1,580 Kg.			1,590 Kg.	
Ball Joint	no			no	
Water Level	no			no	
Height / m.	l/min	m.c.w / Bar	l/min	m.c.w / Bar	
0,50	26,6	0,6 / 0,06	26,6	0,5 / 0,05	
0,75	32,3	0,9 / 0,09	32,3	0,8 / 0,08	
1,00	38,0	1,2 / 0,12	38,0	1,1 / 0,11	
1,25	43,7	1,5 / 0,15	43,7	1,4 / 0,14	
1,50	47,5	1,8 / 0,18	47,5	1,7 / 0,17	
0,75	51,3	2,1 / 0,21	51,3	2,0 / 0,20	
2,00	55,1	2,5 / 0,25	55,1	2,4 / 0,24	
2,50	70,3	3,1 / 0,31	70,3	3,0 / 0,30	



Tobera "MINI VOLCANO ESPECIAL" / "VOLCANO MINI SPECIAL" Nozzle / Ajutage "VOLCANO MINI SPÉCIAL"

Model	WLT 711008		
Dimen. WxH	78x74 mm		
Millim. Outlet Ø	1x5Ø + 18x4Ø		
Connection	G 1" F		
Material	Stainless Steel		
Weight	0,730 Kg.		
Ball Joint	no		
Water Level	no		
Height / m.	l/min	m.c.w / Bar	
0,50	30,1	0,8 / 0,08	
0,75	35,2	1,1 / 0,11	
1,00	42,3	1,6 / 0,16	
1,25	46,3	1,7 / 0,17	
1,50	50,3	1,9 / 0,19	
1,75	54,3	2,0 / 0,20	
2,00	57,3	2,4 / 0,24	
2,50	63,7	3,8 / 0,38	
3,00	69,6	4,2 / 0,42	
3,50	75,1	4,9 / 0,49	
4,00	80,1	5,4 / 0,54	

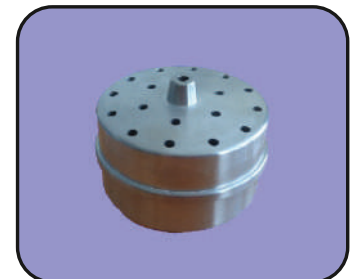
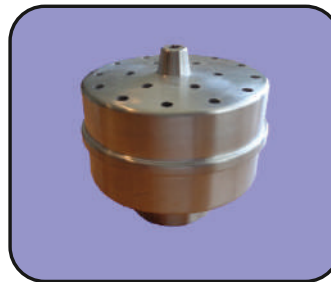

Toberas para fuentes de alta tecnología, fabricadas en Acero inoxidable AISI-304, no son dependientes del nivel del agua.



Nozzles for fountains, high technology, made in Stainless steel AISI-304, not water level dependent.



Ajutages pour fontaines, haute technologie, fabriquées dans Acier inoxydable AISI-304, ne sont pas dépendantes du niveau d'eau.

Tobera "COLUMN DE AGUA" / "WATER COLUMN" Nozzle / Ajutage "COLONNE D'EAU"

TECHNICAL DATA

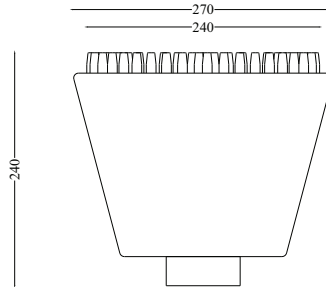
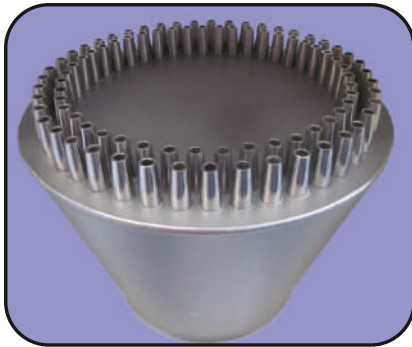

Model	WLT 711066		WLT 711567		WLT 713090	
Dimen. WxH	95x112 mm		95x108 mm		270x240 mm	
Millim. Outlet Ø	1x8+16x6 mm		1x8+16x6 mm		90x6 mm	
Connection	G 1" F		G 1 1/2" M		G 3" F	
Material	Stainless Steel		Stainless Steel		Stainless Steel	
Weight	0,805 Kg.		0,760 Kg.		9,000 Kg.	
Ball Joint	no		no		no	
Water Level	no		no		no	
Height / m.	l/min	m.c.w / Bar	l/min	m.c.w / Bar	l/min	m.c.w / Bar
0,50	86,3	0,5 / 0,05	86,3	0,4 / 0,04	580,0	1,3 / 0,13
0,75	110,7	0,8 / 0,08	110,7	0,7 / 0,07	645,0	2,0 / 0,20
1,00	127,7	1,1 / 0,11	127,7	1,0 / 0,10	770,0	2,5 / 0,25
1,25	154,0	1,4 / 0,14	154,0	1,3 / 0,13	850,0	3,0 / 0,30
1,50	175,5	1,7 / 0,17	175,5	1,8 / 0,18	900,0	3,7 / 0,37
1,75	196,3	2,0 / 0,20	196,3	1,9 / 0,19	980,0	4,3 / 0,43
2,00	214,0	2,4 / 0,24	214,0	2,3 / 0,23	1000,0	4,7 / 0,47
2,50	245,7	3,0 / 0,30	245,7	2,9 / 0,29	1100,0	5,4 / 0,54
3,00	275,6	3,8 / 0,38	275,6	3,7 / 0,37	1245,0	6,3 / 0,63
4,00					1420,0	7,6 / 0,76
5,00					1590,0	8,8 / 0,88
6,00					1785,0	9,0 / 0,90
7,00					1855,0	9,8 / 0,98
8,00					1910,0	10,3 / 1,03



Toberas para fuentes de alta tecnología, fabricadas en Acero inoxidable AISI-304, no son dependientes del nivel del agua.



Nozzles for fountains, high technology, made in Stainless steel AISI-304, not water level dependent.



Ajutages pour fontaines, haute technologie, fabriquées dans Acier inoxydable AISI-304, ne sont pas dépendantes du niveau d'eau.

Tobera "ABANICO DE CHORROS" / "WATER FINGER JET" Nozzle / Ajutage "ÉVENTAIL DE JETS"

Tobera "ESPATULAS DE AGUA" / "FAN WATER JET" Nozzle / Ajutage "ÉVENTAIL LAMINE"

TECHNICAL DATA



Tobera "ABANICO DE CHORROS" / "WATER FINGER JET" Nozzle / Ajutage "ÉVENTAIL DE JETS"

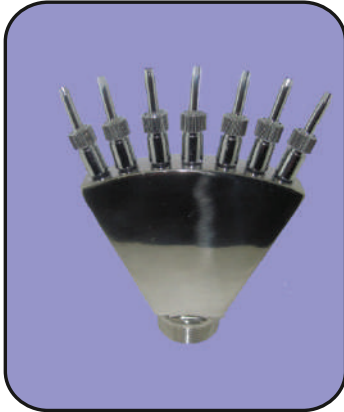

Model	WLT 711085			WLT 711586		
Dimen. WxH	145x185 mm			165x185 mm		
Millim. Outlet Ø	6x4 mm			7x4 mm		
Connection	G 1" F			G 1 1/2" M		
Material	Stainless Steel			Stainless Steel		
Weight	0,840 Kg.			1,210 Kg.		
Ball Joint	no			no		
Water Level	no			no		
Height / m.	l/min	m.c.w / Bar	l/min	m.c.w / Bar	l/min	m.c.w / Bar
1,00	16,3	0,60 / 0,06	19,0	0,70 / 0,07		
1,25	18,0	0,80 / 0,08	21,0	1,00 / 0,10		
1,50	19,5	1,00 / 0,10	23,0	1,20 / 0,12		
1,75	21,2	1,20 / 0,12	24,7	1,50 / 0,15		
2,00	23,0	1,50 / 0,15	26,6	1,80 / 0,18		
2,25	24,5	1,70 / 0,17	28,4	2,00 / 0,20		
2,50	26,0	1,90 / 0,19	30,4	2,30 / 0,23		
3,00	29,4	2,30 / 0,23	34,3	2,80 / 0,28		
3,50	33,0	2,80 / 0,28	38,2	3,40 / 0,34		
4,00	36,0	3,20 / 0,32	41,9	3,90 / 0,39		
4,50	39,5	3,70 / 0,37	45,8	4,40 / 0,44		
5,00	43,2	4,10 / 0,41	50,2	4,90 / 0,49		



Tobera "ESPATULAS DE AGUA" / "FAN WATER JET" Nozzle / Ajutage "ÉVENTAIL LAMINE"

Model	WLT 713486			WLT 711087		WLT 711588	
Dimen. WxH	74x136 mm			100x161 mm		120x230 mm	
Millim. Outlet Ø	66x2mm			93x3,5mm		110x5mm	
Connection	G 3/4" F			G 1" F		G 1 1/2" F	
Material	Stainless Steel			Stainless Steel		Stainless Steel	
Weight	0,425 Kg.			0,680 Kg.		1,610 Kg	
Ball Joint	yes			yes		yes	
Water Level	no			no		no	
Height / m.	l/min	m.c.w / Bar	l/min	m.c.w / Bar	l/min	m.c.w / Bar	
0,50	27	0,90 / 0,09	38	0,50 / 0,05	66,0	0,24 / 0,03	
1,00	32	1,20 / 0,12	58	1,00 / 0,10	105,0	0,49 / 0,05	
1,50	35	1,55 / 0,16	76	1,30 / 0,13	134,0	0,72 / 0,07	
2,00	36	1,74 / 0,18	93	1,60 / 0,16	163,0	1,10 / 0,11	
2,50			106	1,90 / 0,19	185,0	1,22 / 0,12	
3,00			120	2,10 / 0,21	200,0	1,38 / 0,14	
3,50					229,0	1,55 / 0,16	
4,00					248,0	1,69 / 0,17	



Toberas para fuentes de alta tecnología, fabricadas en Acero inoxidable AISI-304, no son dependientes del nivel del agua.



Nozzles for fountains, high technology, made in Stainless steel AISI-304, not water level dependent.



Ajutages pour fontaines, haute technologie, fabriquées dans Acier inoxydable AISI-304, ne sont pas dépendantes du niveau d'eau.

Tobera "CAMPANA" / "WATER BELL" Nozzle / Ajutage "CLOCHE D'EAU"

TECHNICAL DATA



Tobera "CAMPANA BAJA" / "WATER SHORT BELL" Nozzle / Ajutage "COURT CLOCHE D'EAU"



Model	WLT 711023			WLT 711524			WLT 712025		
Dimen. WxH	36x150 mm			47x153 mm			59x160 mm		
Millim. Outlet Ø	5 mm			5 mm			5 mm		
Connection	G 1" F			G 1 1/2" F			G 2" F		
Material	Stainless Steel			Stainless Steel			Stainless Steel		
Weight	0,440 Kg.			0,605 Kg.			0,960 Kg.		
Ball Joint	no			no			no		
Water Level	no			no			no		
Diameter / cm.	l/min	m.c.w / Bar		l/min	m.c.w / Bar		l/min	m.c.w / Bar	
20	17	0,54 / 0,05		20	0,65 / 0,07		23	0,60 / 0,06	
30	22	0,62 / 0,06		25	0,72 / 0,07		27	0,67 / 0,07	
40	26	0,68 / 0,07		30	0,78 / 0,08		32	0,73 / 0,07	
50	31	0,73 / 0,07		35	0,83 / 0,08		37	0,78 / 0,08	
60	34	0,77 / 0,08		38	0,87 / 0,09		41	0,82 / 0,08	
70	37	0,81 / 0,08		41	0,91 / 0,09		43	0,86 / 0,09	
80	40	0,84 / 0,08		45	0,95 / 0,10		48	0,90 / 0,09	
90	43	0,86 / 0,09		47	0,96 / 0,11		50	0,91 / 0,09	
100	46	0,98 / 0,10		50	0,99 / 0,11		52	0,94 / 0,09	



Tobera "CAMPANA ALTA" / "WATER BELL LONG" Nozzle / Ajutage "CLOCHE LONG D'EAU"

Model	WLT 711523			WLT 713424			WLT 711025		
Dimen. WxH	25x285 mm			32x285 mm			38x290 mm		
Millim. Outlet Ø	5 mm			5 mm			5 mm		
Connection	G 1/2" F			G 3/4" F			G 1" F		
Material	Stainless Steel			Stainless Steel			Stainless Steel		
Weight	0,250 Kg.			0,330 Kg.			0,386 Kg.		
Ball Joint	no			no			no		
Water Level	no			no			no		
Diameter / cm.	l/min	m.c.w / Bar		l/min	m.c.w / Bar		l/min	m.c.w / Bar	
20	16	0,55 / 0,06		17	0,54 / 0,05		19	0,54 / 0,05	
30	21	0,63 / 0,06		22	0,62 / 0,06		23	0,62 / 0,06	
40	25	0,69 / 0,07		26	0,68 / 0,07		27	0,68 / 0,07	
50	30	0,74 / 0,07		31	0,73 / 0,07		33	0,73 / 0,07	
60	33	0,78 / 0,08		34	0,77 / 0,08		35	0,77 / 0,08	
70	36	0,82 / 0,08		37	0,81 / 0,08		39	0,81 / 0,08	
80	39	0,85 / 0,09		40	0,84 / 0,08		42	0,84 / 0,08	
90	42	0,87 / 0,09		43	0,86 / 0,09		45	0,86 / 0,09	
100	45	0,89 / 0,09		46	0,98 / 0,10		47	0,98 / 0,10	



Toberas para fuentes de alta tecnología, fabricadas en Acero inoxidable AISI-304, no son dependientes del nivel del agua.



Nozzles for fountains, high technology, made in Stainless steel AISI-304, not water level dependent.



Ajutages pour fontaines, haute technologie, fabriquées dans Acier inoxydable AISI-304, ne sont pas dépendantes du niveau d'eau.

Tobera "CALIZ" / "CALIX" Nozzle / Ajutage "COUPE"

TECHNICAL DATA



Tobera "CALIZ" / "CALIX" Nozzle / Ajutage "COUPE"



Model	WLT 711029		WLT 711520		WLT 712021	
Dimen. WxH	38,5x265 mm		51,5x311 mm		63x314 mm	
Millim. Outlet Ø	5 mm		7 mm		7 mm	
Connection	G 1" F		G 1 1/2" F		G 2" F	
Material	Stainless Steel		Stainless Steel		Stainless Steel	
Weight	0,450 Kg.		0,890 Kg.		1,200 Kg.	
Ball Joint	no		no		no	
Water Level	no		no		no	
Diameter / cm.	l/min	m.c.w / Bar	l/min	m.c.w / Bar	l/min	m.c.w / Bar
20	17	0,70 / 0,07	24	0,60 / 0,06	32	0,40 / 0,04
30	26	0,80 / 0,08	33	0,70 / 0,07	48	0,50 / 0,05
40	35	0,90 / 0,09	42	0,80 / 0,08	64	0,60 / 0,06
50	40	1,00 / 0,10	47	0,90 / 0,09	70	0,70 / 0,07
60	43	1,10 / 0,11	51	1,00 / 0,10	75	0,80 / 0,08
70	47	1,20 / 0,12	58	1,10 / 0,11	80	0,90 / 0,09
80	50	1,30 / 0,13	62	1,20 / 0,12	85	1,00 / 0,10
90	53	1,42 / 0,14	65	1,30 / 0,13	91	1,10 / 0,11
100	55	1,55 / 0,15	69	1,40 / 0,14	96	1,20 / 0,12
120					105	1,30 / 0,13
130					111	1,40 / 0,14
140					115	1,50 / 0,15
150					121	1,60 / 0,16



Tobera "CORONA-PALMERA" / "CROWN-PALM" Nozzle / Ajutage "COURONNE-PALMIER"

CROWN-PALM				CROWN-PALM		
Model	WLT 71152215			WLT 71302230		
Dimen. WxH	110x170 mm			170x230 mm		
Millim. Outlet Ø	18x4 mm			21x10 mm		
Connection	G 1 1/2" F			G 3" F		
Material	Stainless Steel			Stainless Steel		
Weight	1,120 Kg.			10,000 Kg.		
Ball Joint	no			no		
Water Level	no			no		
Height / m.	Diameter	l/min	m.c.w / Bar	Diameter	l/min	m.c.w / Bar
0,50	110	70	0,70 / 0,07	120	300	0,70 / 0,07
0,75	120	96	1,00 / 0,10	150	380	1,00 / 0,10
1,00	190	115	1,30 / 0,13	220	420	1,30 / 0,13
1,25	200	131	1,60 / 0,16	250	500	1,60 / 0,16
1,50	250	146	1,90 / 0,19	320	540	1,90 / 0,19
1,75	260	157	2,20 / 0,22	380	625	2,40 / 0,24
2,00	350	167	2,60 / 0,26	420	650	2,70 / 0,27
2,50	360	180	3,30 / 0,33	520	730	4,20 / 0,42
3,00				620	840	5,10 / 0,51
3,50				720	920	5,80 / 0,58

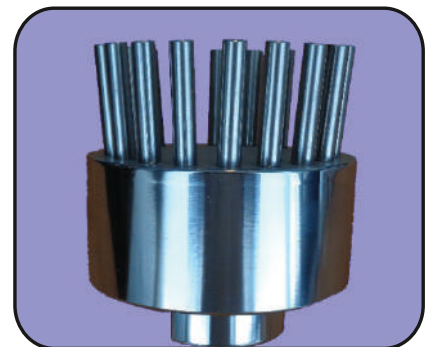
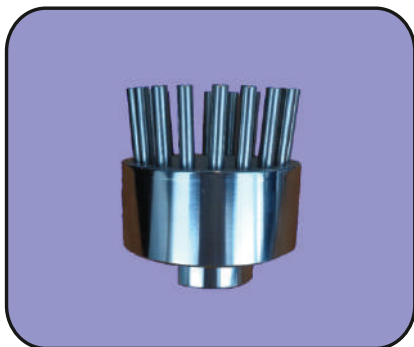

Toberas para fuentes de alta tecnología, fabricadas en Acero inoxidable AISI-304, no son dependientes del nivel del agua.



Nozzles for fountains, high technology, made in Stainless steel AISI-304, not water level dependent.



Ajutages pour fontaines, haute technologie, fabriquées dans Acier inoxydable AISI-304, ne sont pas dépendantes du niveau d'eau.

Tobera "FUENTES SECAS y PISCINAS" / "DRY FOUNTAINS AND POOLS" Nozzle

/ Ajutage "FONTAINES SÈCHES ET PISCINES"

TECHNICAL DATA



Tobera "FUENTES SECAS y PISCINAS BI-DIRECCIONAL" / "DRY FOUNTAINS AND POOLS" Nozzle / Ajutage "FONTAINES SÈCHES ET PISCINES"

PERFORMANCE TABLE

Model	WLT 71100410	
Dimen. WxH	66x54 mm	
Millim. Outlet Ø	10 mm	
Connection	G 1" F	
Material	Stainless Steel	
Weight	0,735 Kg.	
Angle	55° / 60°	
Water Level	no	
Ball Joint	no	
Height / m.	l/min	m.c.w / Bar
0,50	15,0	0,7 / 0,07
0,75	19,0	1,0 / 0,10
1,00	21,0	1,3 / 0,13
1,25	25,0	1,7 / 0,17
1,50	28,0	1,9 / 0,19
1,75	31,0	2,4 / 0,24
2,00	33,0	2,7 / 0,27
2,50	37,0	3,4 / 0,34



Tobera "ROT HISBIS" / "ROT HISBIS" Nozzle / Ajutage "ROT HISBIS"

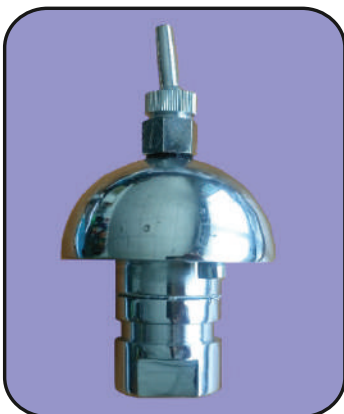

PERFORMANCE TABLE

Model	WLT 711071T / WLT 711570T	
Dimen. WxH	99x170 mm	
Millim. Outlet Ø	5 mm	
Connection	G 1" F / G 1 1/2"	
Material	Stainless Steel	
Weight	1,400 / 1.450 Kg.	
Ball Joint	no	
Water Level	no, but flush with level	
Height / m.	l/min	m.c.w / Bar
0,50	11,7	0,8 / 0,08
0,75	15,9	1,0 / 0,10
1,00	19,2	1,3 / 0,13
1,25	21,9	1,6 / 0,16
1,50	24,3	1,9 / 0,19
1,75	26,1	2,2 / 0,22
2,00	27,9	2,5 / 0,25
2,50	33,3	3,0 / 0,30

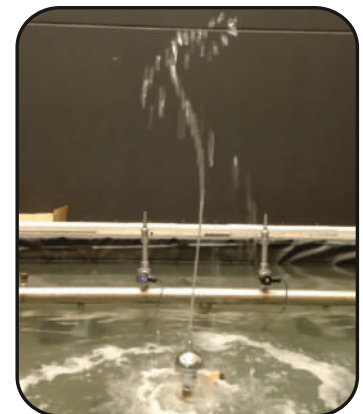

Toberas para fuentes de alta tecnología, fabricadas en Acero inoxidable AISI-304, no son dependientes del nivel del agua.



Nozzles for fountains, high technology, made in Stainless steel AISI-304, not water level dependent.



Ajutages pour fontaines, haute technologie, fabriquées dans Acier inoxydable AISI-304, ne sont pas dépendantes du niveau d'eau.

Tobera "PIROUETTE" / "PIROUETTE" Nozzle / "PIROUETTE"

TECHNICAL DATA



Tobera "PIROUETTE NEST" / "PIROUETTE NEST" Nozzle / Ajutage "PIROUETTE NEST"

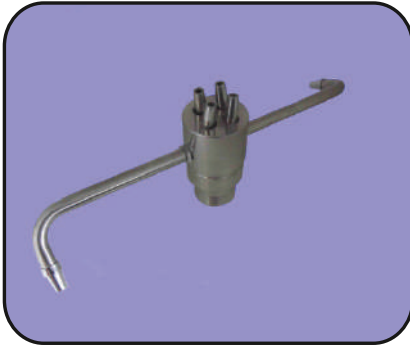

PIROUETTE NEST		
Model	WLT 901580	
Dimen. Wide Ø	455 mm	
Millim. Outlet Ø	4x6 mm	
Connection	G 1 1/2" M	
Material	Stainless Steel	
Weight	1,000 Kg.	
Ball Joint	no	
Water Level	no	
Height / m.	l/min	m.c.w / Bar
0,50	33	0,70 / 0,07
0,75	41	1,00 / 0,10
1,00	47	1,30 / 0,13
1,25	56	1,60 / 0,16
1,50	58	1,90 / 0,19
1,75	70	2,20 / 0,22
2,00	76	2,60 / 0,26
2,50	97	3,30 / 0,33



Tobera "PIROUETTE" / "PIROUETTE" Nozzle / Ajutage "PIROUETTE"

PIROUETTE						
Model	WLT 901086		WLT 901587		WLT 902088	
Dimen. Wide Ø	382 mm		455 mm		475 mm	
Millim. Outlet Ø	8x7 mm		8x8 mm		8x8 mm	
Connection	G 1" F		G 1 1/2" M		G 2" F	
Material	Stainless Steel		Stainless Steel		Stainless Steel	
Weight	1,000 Kg.		1,263 Kg.		1,700 Kg	
Ball Joint	no		no		no	
Water Level	no		no		no	
Height / m.	l/min	m.c.w / Bar	l/min	m.c.w / Bar	l/min	m.c.w / Bar
0,50	46	0,70 / 0,07	76	0,70 / 0,07	76	0,70 / 0,07
0,75	58	1,00 / 0,10	92	1,00 / 0,10	92	1,00 / 0,10
1,00	66	1,30 / 0,13	101	1,60 / 0,16	101	1,60 / 0,16
1,25	78	1,60 / 0,16	119	1,70 / 0,17	119	1,70 / 0,17
1,50	87	1,90 / 0,19	136	1,80 / 0,18	136	1,80 / 0,18
1,75	97	2,20 / 0,22	150	2,00 / 0,20	150	2,00 / 0,20
2,00	105	2,60 / 0,26	164	2,40 / 0,24	164	2,40 / 0,24
2,50	119	3,30 / 0,33	187	3,20 / 0,32	187	3,20 / 0,32
3,00	133	4,00 / 0,40	209	3,90 / 0,39	209	3,90 / 0,39
3,50			228	4,70 / 0,47	228	4,70 / 0,47
4,00			246	5,40 / 0,54	246	5,40 / 0,54
5,00					282	7,00 / 0,70

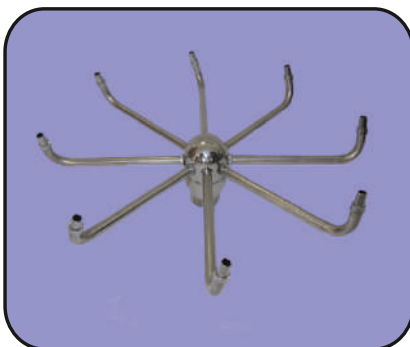

Toberas para fuentes de alta tecnología, fabricadas en Acero inoxidable AISI-304, no son dependientes del nivel del agua.



Nozzles for fountains, high technology, made in Stainless steel AISI-304, not water level dependent.



Ajutages pour fontaines, haute technologie, fabriquées dans Acier inoxydable AISI-304, ne sont pas dépendantes du niveau d'eau.



PANTALLAS DE AGUA / WATER SCREENS					
Model	WLT 600080		WLT 600100		WLT 600100
Dimen. Height	6 meters		8 meters		18 meters
Dimen. Wide Ø	12 meters		18 meters		45 meters
Connection	DN 80		DN 100		DN 150
Material	Stainless Steel		Stainless Steel		Stainless Steel
Weight	20,00 Kg.		24,00 Kg.		38,00 Kg
Ball Joint	no		no		no
Water Level	no		no		no
	M3/h	m.c.w / Bar	M3/h	m.c.w / Bar	M3/h m.c.w / Bar
	40m3/h	12,00 / 1,20	60m3/h	16,00 / 1,60	60m3/h 36,00 / 3,60



Toberas para fuentes de alta tecnología, fabricadas en Acero inoxidable AISI-304, no son dependientes del nivel del agua. Diseñadas para obtener una gran pantalla en la cual proyectar espectáculos multimedia



Nozzles for fountains, high technology, made in Stainless steel AISI-304, not water level dependent. Designed to obtain a big screen in which projecting multimedia spectacles



Ajutages pour fontaines, haute technologie, fabriquées dans Acier inoxydable AISI-304, ne sont pas dépendantes du niveau d'eau. Conçu pour obtenir un grand écran dans lequel la projection des lunettes multimédias

Tobera "JUMPING JET" / "JUMPING JET" Nozzle / Ajutage "JUMPING JET"

TECHNICAL DATA

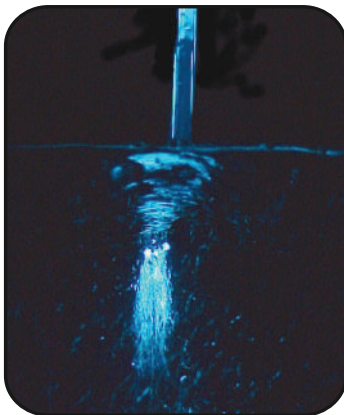
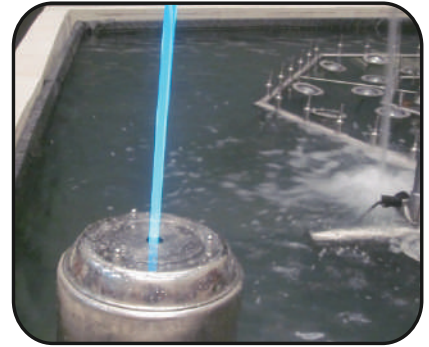

JUMPING JET							
Model / Modelo	WLT 606214		WLT 606118		WLT 606120		
Dimen. Outlet / Salida	14mm		18mm		20mm		
Dimen. Height / Altura	620mm		700mm		700mm		
Dimen. Wide Ø / Ancho	390mm		480mm		480mm		
Connection / Conexión	1 1/4"		1 1/2"		1 1/2"		
Material / Material	Stainless Steel		Stainless Steel		Stainless Steel		
Weight / Peso	25 Kg		30 Kg		30 Kg		
Controller / Controlador	si		si		si		
Water Level / Nivel agua	300mm		400mm		400mm		
Flow / Pressure	l/min	m.c.w	l/min	m.c.w	l/min	m.c.w	
Caudal / Presion	75 / 100	4,00 / 5,00	100 / 125	5,00 / 6,00	110 / 135	5,50 / 6,50	
Light / Iluminación	Led RGB 6W		Led RGB 6W		Led RGB 6W		





Tabla de Alcances / Performance Ranges / Rang de performance



Jumping Jet es una fuente de chorros a pulsos precisos y cristalino. permitiendo la creación de juegos de agua incomparables a todo lo que ya existe hasta el momento en la tecnología del agua. Un primer chorro compacto y aparentemente solido es proyectado violentamente en el aire, después desaparece en un cerrar de ojos a través de una pequeña abertura que hay en el suelo, en un instante, resurge de este mismo devuelto como si una raqueta de tenis devolviera la pelota, vuelve a desaparecer y tres, cuatro, cinco chorros muy breves se suceden uno de tras del otro a través del aire. posteriormente, todo se une en un chorro continuo creando un arco completo y solido. El espectador atónito es continuamente sorprendido por la gran variedad de secuencias que se suceden una tras de otra. El secreto de esta maravilla encuentra su origen en una mecánica de alta precisión minuciosamente fabricada y largamente testeada, que permite la emisión de chorros perfectamente segmentados. Un gran numero de Jumping jet puede crear una combinación infinita de juegos de agua. El conjunto esta controlado por un único panel de control

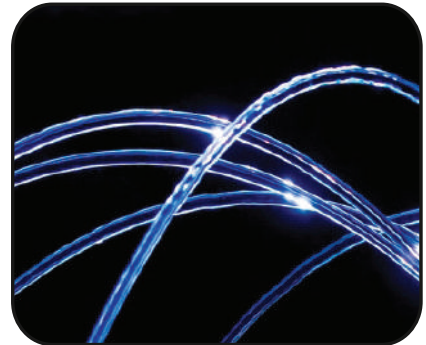
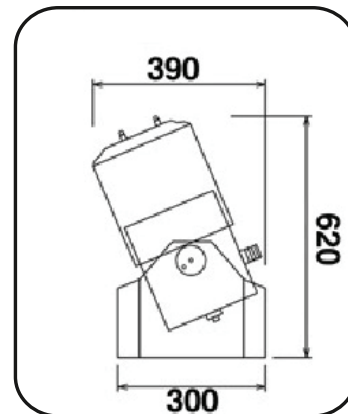
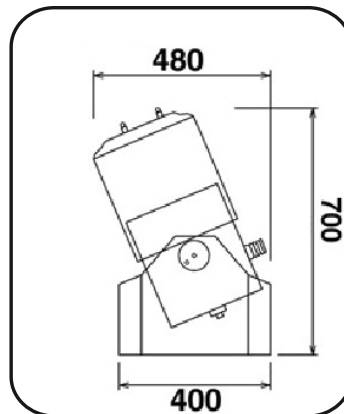
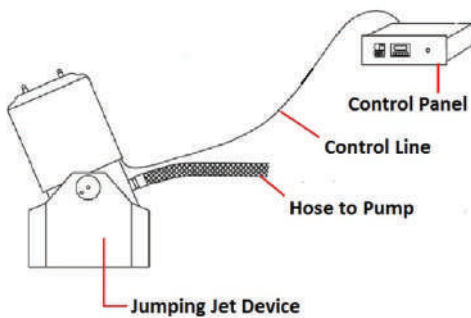
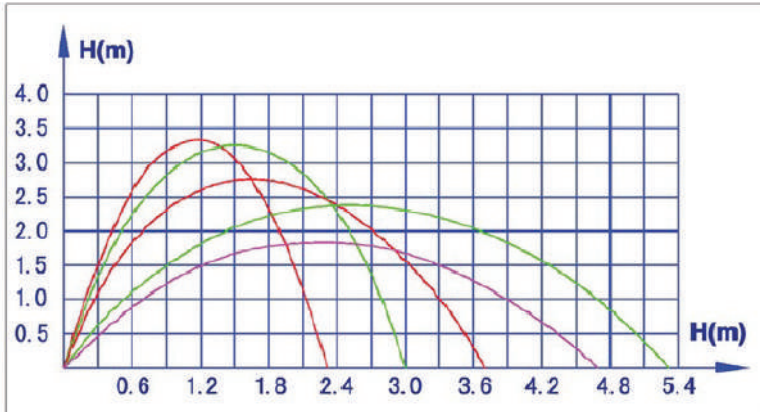

Jumping Jet Nozzle or device is a fountain with blown throws allowing creation of incomparable games of water existing up to present in the technology of the throws of water. Judge yourself: a first throw, so compact as it parried solid, is violently cast in air, then disappears in a twink, in a small opening on the soil. Afterwards, it re-emerges from this last point, springing up as a tennis ball hitting a racket. It disappears again in a collector and three, four, five very short throws succeed one after another in salvo across the space. They rush in turns into the collector and come out again from it immediately in form of a long uninterrupted throw. The astonished spectator is persistently surprised by the big variety of sequences which succeed one after another. The secret of this wonder finds its origin in the mechanics, the high precision thoroughly worked out and tested for a long time allows programming of the perfectly segmented throws. Group is commanded by a central control panel.



Le Jumping Jet est une fontaine à jets pulsés permettant la création de jeux d'eau incomparables à tout ce qui existant jusqu'ici dans la technologie des jets d'eau. Jugez plutôt: un premier jet, si compact qu'il paraît solide, est violemment projeté en l'air, puis disparaît en un clin d'œil dans une petite ouverture au sol. L'instant d'après, il resurgit de cette dernière, bondissant comme une balle de tennis percutant une raquette. Il disparaît à nouveau dans un collecteur et trois, quatre, cinq jets très brefs se succèdent en salve à travers l'espace. ils s'engouffrent tout à tour dans le collecteur et en ressortent aussitôt sous forme d'un long jet continu. Le spectateur étonné est continuellement surpris par la grande variété de séquences qui se succèdent les unes aux autres. Le secret de cette merveille trouve son origine dans une mécanique e haute précision minutieusement élaborée et longuement testée, que permet l'émission de jets parfaitement segmentés. L'ensemble est commande par une unité centrale.

“NUBE de PULVERIZACIÓN” / “SPRAYING CLOUDS JET” / “NUAGES PULVÉRISATION”

TECHNICAL DATA



Model	WLT 711506		WLT 712007		WLT 713009	
Dimen. WxH	115x150 mm		124x160 mm		210x250 mm	
Millim. Outlet Ø	6x4 mm		7x6 mm		9x6 mm + 1x8 mm	
Connection	G 1 1/2" F		G 2" F		G 3" F	
Material	Stainless Steel		Stainless Steel		Stainless Steel	
Weight	1,630 Kg.		1,690 Kg.		4,750 Kg	
Ball Joint	no / optional		no / optional		no / optional	
Water Level	no		no		no	
Height / m.	l/min	m.c.w / Bar	l/min	m.c.w / Bar	l/min	m.c.w / Bar
0,50	15,0	2,30 / 0,23	25,0	2,90 / 0,29	39	3,50 / 0,35
1,00	26,0	4,00 / 0,40	44,0	4,80 / 0,48	67	6,80 / 0,68
1,50	37,0	6,50 / 0,65	55,0	6,70 / 0,67	84	9,00 / 0,90
2,00	49,0	11,00 / 1,10	70,0	8,70 / 0,87	105	11,50 / 1,15
2,50	54,0	11,50 / 1,15	74,0	11,00 / 1,10	112	12,80 / 1,28
3,00	65,0	13,80 / 1,38	88,0	13,20 / 1,32	136	14,20 / 1,42
3,50	76,0	16,10 / 1,61	102,0	15,40 / 1,54	158	16,56 / 1,66
4,00			116,0	17,60 / 1,76	180	18,93 / 1,89
4,50			130,0	19,80 / 1,98	201	21,30 / 2,13
5,00					225	23,66 / 2,36
5,50					245	26,03 / 2,60
6,00					268	28,40 / 2,84



Wind Resistance					
Resistencia al viento					
Noise					
Ruido					
Water Dependent	No / Non				
Dependencia Nivel Agua	No				
Straightener Vane	No / Non				
Centrador Chorro	No				
Ball Join	No / Optional				
Rotula	No / Opcional				



Toberas para fuentes de alta tecnología, fabricadas en Acero inoxidable AISI-304, no son dependientes del nivel del agua.



Nozzles for fountains, high technology, made in Stainless steel AISI-304, not water level dependent.



Ajutages pour fontaines, haute technologie, fabriquées dans Acier inoxydable AISI-304, ne sont pas dépendantes du niveau d'eau.

"CORTINA HILO DE MYLAR" / "MYLAR LACE, WATER CURTAIN" / "MYLAR RIDEAU D'EAU"

TECHNICAL DATA



Diferentes medidas "bajo pedido" / Different Sizes "Under Request" / Différentes mesures "sous commande"

En Acero inoxidable y Latón / Made in Stainless Steel and Brass / Dans l'Acier inoxydable et Laiton

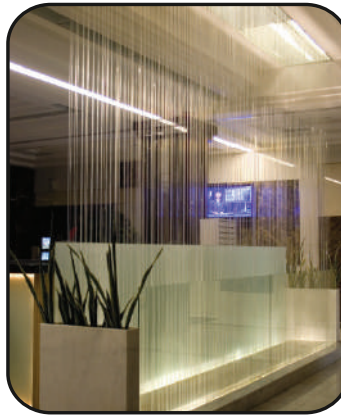

CARACTERÍSTICAS // CHARACTERISTICS

Artículo // Article	WLT 603805	WLT 603850	WLT 603810	WLT 603899	WLT 603806
Nombre // Name	Boquilla / Nozzle	Hilo / Lace	Hilo / Lace	Espaciador / Spacer	Peso / Weight
Dimensiones / Dimension	33x22 mm	50m/4,2mm	100m/4,2mm	On Request	36x24 mm
Millim. Outlet Ø	5 mm	-	-	-	-
Material // Material	LATÓN / BRASS	MILAR / MYLAR	MILAR / MYLAR	STAINLESS STEEL	STAINLESS STEEL
Peso // Weight	50 gr.	75 gr.	150 gr.	480 gr. / meter	60 gr.
Caudal // Flow	0,5 l/min	-	-	-	-
Conexión // Connection	G 3/8" H-H	-	-	-	-

Distancia aconsejable entre boquillas, 30 mm // Recommended operating distance between nozzles, 30 mm

Wind Resistance	
Resistencia al viento	
Noise	
Ruido	
Lace Spacer	Optional
Espaciador de hilo	Opcional
Straightener Vane	Optional
Centrador Chorro	Opcional
Weight	No / Optional
Peso	No /Opcional

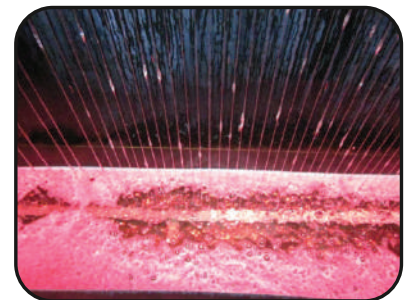
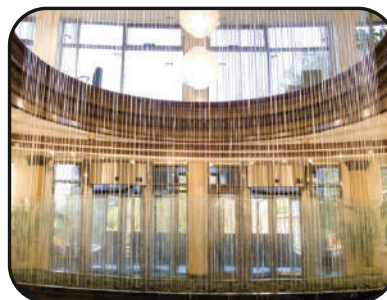

Toberas para fuentes de alta tecnología, fabricadas en Latón y complementos en Acero inoxidable AISI-304, no son dependientes del nivel del agua.



Nozzles for fountains, high technology, made in Brass an Stainless steel AISI-304 accessories, not water level dependent



Ajutages pour fontaines, haute technologie, fabriqué en laiton et des accessoires acier inoxydable AISI-304, ne sont pas dépendantes du niveau d'eau.

"CORTINA HILO DE MYLAR" / "MYLAR LACE, WATER CURTAIN" / "MYLAR RIDEAU D'EAU"

TECHNICAL DATA

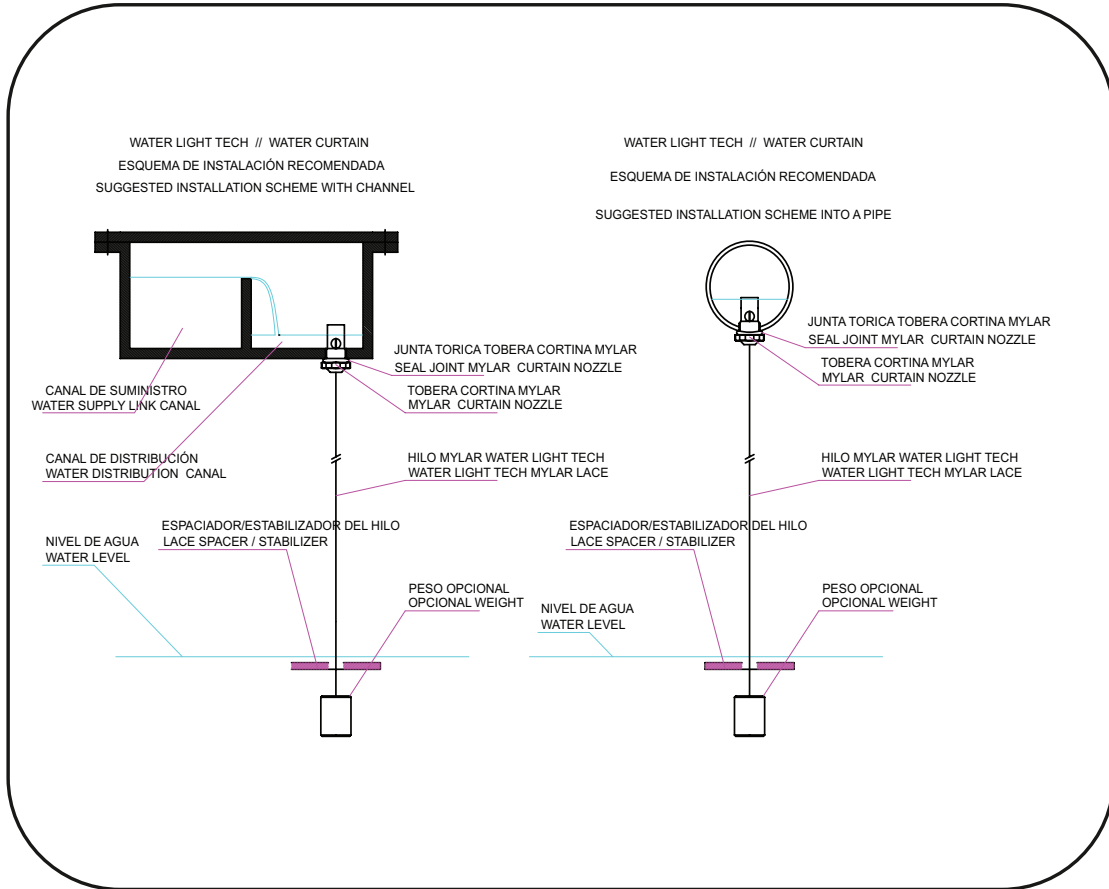



<http://waterlight-tech.com/Musical-Fountains/>

Water Light Tech conoce perfectamente el sistema de las **Fuentes Musicales** y su complejidad a la hora de desarrollar un proyecto en su ejecución y diseño. Nosotros tenemos una gran experiencia desde hace años en este sector y podemos ayudar a nuestros clientes en todos y cada uno de los trabajos para la realización de un gran proyecto de **Fuente Musical**.



- Realización de proyectos en 3D bajo demanda. <http://www.youtube.com/watch?v=1f6frilodJO>
- Nuestra tecnología nos permite todo tipo de realización y animación en **Fuentes Musicales**, todo ello realizado por nuestro personal altamente cualificado, todos los trabajos se realizan en nuestras instalaciones sin ninguna dependencia de empresas externas con los sobre costes y dificultades adicionales que supone no realizar todo el sistema por la misma empresa. Nosotros le facilitamos la puesta en marcha de la misma con el completo asesoramiento técnico de nuestro personal. Además vía internet podemos modificar y realizar los ajustes que la fuente necesite en cada momento así como su actualización.
- Los escenarios acuáticos de la **Fuente Danzarina** o **Fuente Danzante** son adaptados a través de nuestro software mediante el sistema **DMX** "real", otras empresas definen el **DMX** como sistema de control, sin saber el significado del mismo, pero nosotros usamos este protocolo de comunicación realmente como se debe utilizar, de una forma flexible y personalizada, adaptando todos nuestros productos y convirtiéndolos en un sistema **DMX**, realizando una auténtica **Fuente Musical**.
- La coreografía, es completamente desarrollada en nuestras instalaciones, ajustándola hasta lo más pequeños detalles y consiguiendo que la **Fuente Musical**, se convierta en todo un espectáculo que integre todos los elementos, agua, color, música, laser, pantallas de proyección, en un sistema que funcione en perfecta coordinación y armonía.

Fuente Musical Incluye:

- Toda la electrónica **DMX** necesaria, Ordenador de control, Altavoces y Amplificadores, mesas de mezcla.
- Con el Software se puede realizar todo tipo de ajustes de sincronización del agua, iluminación y música.
- Posibilidad de reprogramar vía internet la **Fuente Musical**.
- Conexión de todos los equipos fácilmente sin cableado excesivo dentro de la **Fuente Musical**.
- Total posibilidad de control de diferentes aparatos adicionales como maquinas de humo, laser, pantallas audiovisuales, pirotecnia mediante el protocolo **DMX**.



<http://waterlight-tech.com/Musical-Fountains/>

Water Light Tech, knows perfectly the system of the **Musical Fountains** and its complexity at the time of developing a project in its execution and design. We have a big experience of many years in this field and can help our clients in every work for the achievement of a big project of a **Musical Fountains**.



- Project achievement in 3D under request. <http://www.youtube.com/watch?v=1f6frilodJO>
- Our technology allows us all kinds of achievements and animations in the **Musical Fountains**, all realized by our highly qualified staff, all the entire works are carried out in our facilities without any dependence on the external companies with their extra costs and additional difficulties that the whole system supposes without realizing for the company. We facilitate the starting of the fountain with the finished technical advices from our technical staff. Also, through internet connection we can modify and realize the final adjustments that the fountain would need in every moment as well as its update.
- The aquatic stages of the **Dancing Fountain** or **Musical Fountain** are adapted through our software with a "real" **DMX** system, other companies define the **DMX** as a control system, without knowing the meaning of that, but we use this communication protocol how it is necessary it to be used, in a flexible and personalized way, adapting all our products and turning them into a system **DMX**, realizing an authentic **Musical Fountain**.
- The choreography, it is completely developed in our facilities, fitting it even up to the smallest details and achieving that the **Musical Fountain** turns into a whole spectacle that integrates all the elements: water, color, music, laser, water projection screens, in a system that works in perfect coordination and harmony.

Musical Fountain Include :

- The entire electronics **DMX** devices necessary, Laptop Computer for control, Loudspeakers and Amplifiers, mixing board fader.
- With the Software it is possible to realize all kinds of adjustments of synchronization of the water, lighting and music.
- Possibility of reprogramming by Internet the **Musical Fountain**.
- Connection of the entire equipments easily without excessive wiring inside the Musical Fountain.
- Entire possibility of control from different additional devices as smoke devices, laser, audio-visual screens, fireworks through **DMX** protocol.

<http://waterlight-tech.com/Musical-Fountains/>

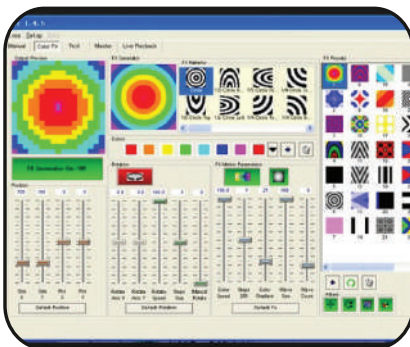
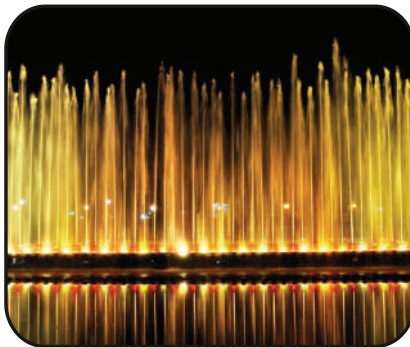

"FUENTES MUSICALES" / "MUSICAL FOUNTAINS" / "FONTAINES MUSICALES"

TECHNICAL DATA



<http://waterlight-tech.com/Musical-Fountains/>

Water Light Tech, connaît parfaitement le système des **Fontaines Musicales** et sa complexité à l'heure de développer un projet dans son exécution et dessin. Nous avons une grande expérience depuis des années dans ce secteur et nous pouvons aider nos clients dans tous et chacun des travaux pour la réalisation d'un grand projet de Fontaine Musicale.



- Réalisation de projets dans 3D sous demande. <http://www.youtube.com/watch?v=1f6frilodJQ>
- Notre technologie nous permet au moyen de l'infographie animée, la simulation et d'animation des **Fontaines Musicales**, tout cela réalisé par notre personnel hautement qualifié, tous les travaux sont réalisés dans nos installations sans aucune dépendance d'autres entreprises externes avec eux sur les prix et les difficultés additionnelles que tout le système suppose de ne pas réaliser par la même entreprise. Nous lui facilitons la mise en marche de la même avec la consultation complète technique de notre personnel. De plus avec l'internet nous pouvons modifier et réaliser les ajustages dont la fontaine a besoin dans chaque moment ainsi que son actualisation.
- Les scènes aquatiques de la **Fontaine Musical** ou la **Fontaine Dansante** sont adaptées à travers de notre software grâce au système **DMX "réel"**, d'autres entreprises définissent le DMX comme un système de contrôle, sans savoir la signification du même, mais nous utilisons réellement ce protocole de communication comment il faut utiliser, d'une forme flexible et personnalisée, en adaptant tous nos produits et en les transformant en système **DMX**, en réalisant une authentique **Fontaine Musicale**.
- La chorégraphie, est complètement développée dans nos installations, en ajustant même les plus petits détails pour obtenir que la **Fontaine Musicale**, il devienne tout un spectacle qui compose tous les éléments, eau, couleur, musique, laser, des écrans de projection, dans un système qui fonctionne avec une coordination parfaite et harmonique.

Fontaine Musicale Inclut :

- Toute l'électronique **DMX** nécessaire, Ordinateur de contrôle, Haut-parleurs et Amplificateurs, de console de mixage.
- Avec le Software on peut réaliser un ample spectre d'ajustages pour le synchronisation de l'eau, d'éclairage et de musique.
- La possibilité de reprogrammer voie internet la **Fontaine Musicale**.
- Le connexion de toutes les équipes facilement sans des fils électriques excessifs dans la **Fontaine Musicale**.
- Possibilité totale de contrôle de différents appareils additionnels comme machines de fumée, laser, écrans audiovisuels, pyrotechnie grâce au protocole DMX.



<http://waterlight-tech.com/Musical-Fountains/>

"WATER-MUSIC SWITCH"

TECHNICAL DATA



<http://www.youtube.com/watch?v=kan0K0gkEDo>



Water-Music Switch son electro-válvulas de alto rendimiento, sumergible IP-68 y estas especialmente diseñadas para el control y rápida actuación en las fuentes cibernéticas, fuentes interactivas y fuentes musicales. El hecho de que sean sumergibles facilita su instalación y versatilidad ya que se pueden usar tanto dentro como fuera del nivel del agua. Para todo tipo de fuentes; **fuentes ornamentales, fuentes cibernéticas, fuentes interactivas y fuentes musicales**

Además con nuestro departamento de **I+D+i** nuestros técnicos en **Water Light Tech** son capaces de desarrollar cualquier cuadro de control que maneje a nuestra demanda los diferentes cambios que queramos hacer en cada caso y con la implementación del protocolo **DMX** conseguir de este modo el efecto acuático deseado.



Además tenemos la posibilidad de diseñar los aparatos necesarios para poderlos encastrar en las fuentes secas o transitables, mediante los nichos o hornacinas que serán enrasadas con el nivel del terreno en las cuales todos los componentes necesarios son alojados para el correcto funcionamiento de la fuente, el **Water-Music Switch, foco sumergible, boquillas** y elementos de regulación.



<http://www.youtube.com/watch?v=kan0K0gkEDo>

Water-Music Switch are high performance electro-valves submersible IP-68 and these are specially designed for the control and quick performance in the cybernetic fountains, interactive and musical fountains. The fact that they are submersible, facilitates the installation and versatility since they can be used inside as well as outside the water level. For all kinds of fountains: **ornamental fountains, cybernetic fountains, interactive fountains and musical fountains.**

In addition to our department of **R & D**, our technical staff in **Water Light Tech** are able to develop any control panel that controls the entire effects following our demands to make the different changes we want to do in each case and with the implementation of the **DMX** protocol thereby achieving the desirable aquatic effect.

We have the possibility of designing the necessary devices in order to settle them in the dry or walk fountains through the niches that will be placed at the ground level and inside these niches will be lodged all the necessary components for the correct functioning of the fountain, **Water-Music Switch, submersible light fixtures, nozzles and regulation elements.**



TABLA DE TRABAJO // PERFORMACE TABLE // TABLE DE PERFORMACE

Model	WLT 60012	WLT 60010	WLT 60015	WLT 60020
CONNECTION	G 1/2" H-H	G 1" H-H	G 1 1/2" H-H	G 2" H-H
VOLTAGE	24VDC	24VDC	24VDC	24VDC
POWER	20W	20W	20W	20W
OPERATING PRESSURE	0-5 Atm.	0-5 Atm.	0-5 Atm.	0-5 Atm.
MAX. PRESSURE	10 Atm.	10 Atm.	11 Atm.	11 Atm.
FLUID OPERATIONAL TEMP.	60 C // 140 F	60 C // 140 F	60 C // 140 F	60 C // 140 F
TYPE	NC	NC	NC	NC
MATERIAL	STAINLESS STEEL	STAINLESS STEEL	STAINLESS STEEL	STAINLESS STEEL
IP PROTECTION GRADE	IP 68	IP 68	IP 68	IP 68
LENGTH	69 mm	81 mm	121 mm	165 mm
WIDE	56 mm	70 mm	95 mm	125 mm
HEIGHT	105 mm	120 mm	155 mm	180 mm
WEIGHT	0,880 Kg.	1,200 Kg.	2,200 Kg.	3,800 Kg.

<http://waterlight-tech.com/Musical-Fountains/>



WATER-MUSIC SWITCH WITH "NICHE"
WATER-MUSIC SWITCH CON "HORNACINA" EMPOTRABLE

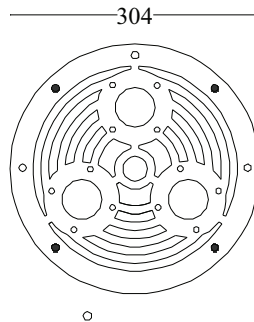
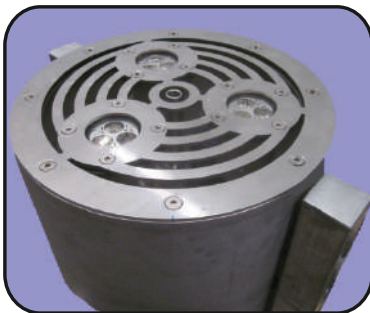

DIFFERENT SIZES AND DESIGN ACCORDING WITH THE PROJECT
DIFERENTES MEDIDAS Y DISEÑOS DE ACUERDO CON EL PROYECTO



Enrasado con el piso
Ground level

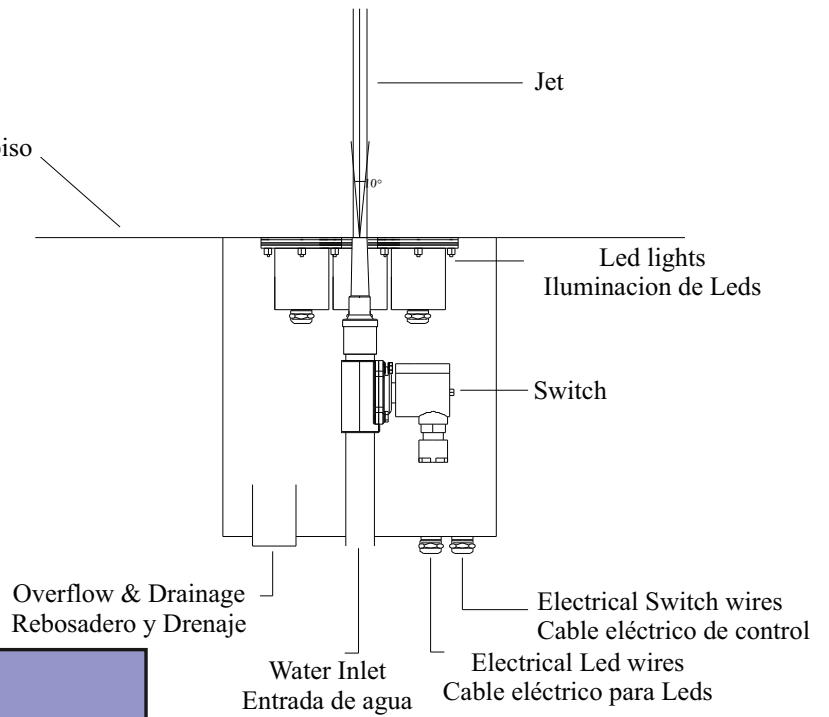

YOUTUBE: CLICK AQUÍ / CLICK HERE
<https://www.youtube.com/watch?v=CEEgybSO4I0>



<http://www.youtube.com/watch?v=kanOKOgkEDo>

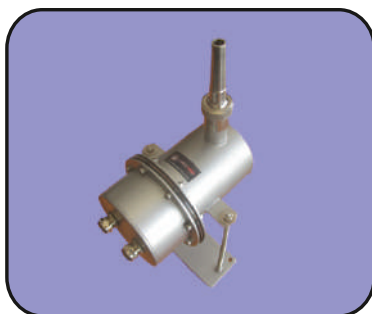

Les **Water-Music Switch** sont electro-valves de haut rendement, submersible IP -68 et est spécialement dessinée pour le contrôle et le rapide comportement dans les fontaines cybernéticiennes, les fontaines interactives et les fontaines musicales. Le fait qu'ils sont submersibles il facilite son installation et versatilité puisqu'ils peuvent s' utiliser tant à l'intérieur comme en dehors du niveau d'eau. Pour toute espèce de fontaines; des fontaines ornementales, des fontaines cybernéticiennes, des fontaines interactives et des fontaines musicales.

A moyen de notre département **d'I+D+i**, nos techniciens dans le Water Light Tech sont capables de développer tout tableau de contrôle qui manie à notre demande différents changements que voulons faire dans chaque cas et avec l'implémentation du protocole **DMX**, obtenir de cette façon l'effet aquatique désiré.



De plus nous avons la possibilité de dessiner les appareils nécessaires pour eux pouvoir encastré dans les fontaines sèches ou praticables, grâce aux niches qui seront intégrés avec le niveau du terrain dans lesquelles tous les composants nécessaires sont logés pour le fonctionnement correct de la fontaine, le **Water-Music Switch**, le projecteur submersible, les ajutages et les éléments de régulation.

Water Switch DMX, es un Switch de actuación rápida completamente gobernado por control **DMX** el cual puede ser colocado en serie con cualquier otro aparato bajo dominio del protocolo **DMX** real.

Water Switch DMX, it is a Switch of fast reply, completely governed by **DMX** control, which can be placed in series with any other devices. Under mastery of the real **DMX** protocol.

Water Switch DMX, c'est un Switch de réponse rapide, complètement gouvernée par le contrôle de **DMX**, qui peut être placé en série avec autres appareils. Sous la maîtrise du protocole **DMX** réel.



<http://waterlight-tech.com/Musical-Fountains/>



Composición en formación en "S" 150 Switch controlados mediante protocolo DMX

Composition in formation of "S" 150 Switch controlled by DMX protocol.

Une composition dans formation "S" 150 Switch contrôlés grâce à un protocole DMX

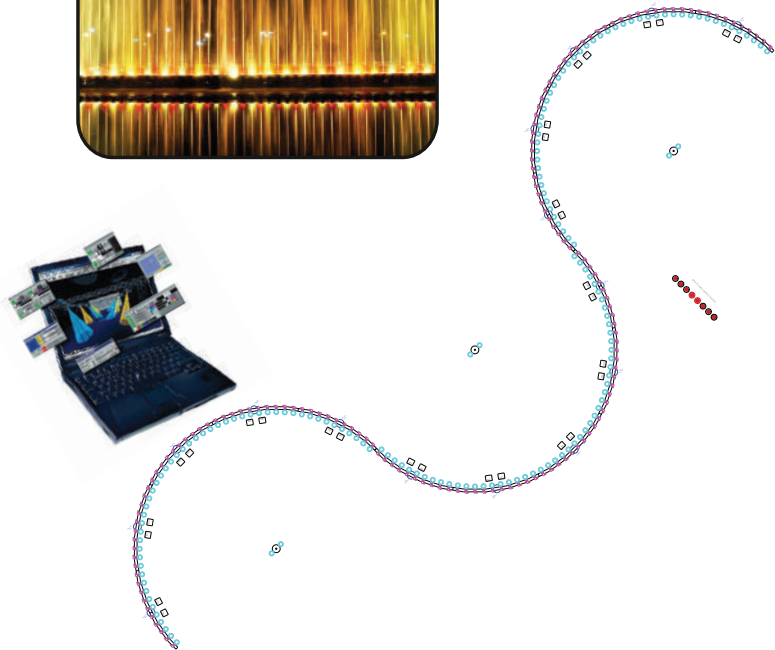

<http://waterlight-tech.com/Musical-Fountains/>

Tobera "DUAL" / "DUAL" Nozzle / Ajutage "DUAL"

TECHNICAL DATA



Tobera "DUAL" / "DUAL" Nozzle / Ajutage "DUAL"

DUAL NOZZLE				
	NOZZLE		NOZZLE + BASE	
Model / Modelo	WLT 6001601		WLT 6001602	
Dimen. Outlet / Salida	60mm		60mm	
Dimen. Height / Altura	690mm		795mm	
Dimen. Wide Ø / Ancho	360mm		440mm	
Connection / Conexión	4 x 1 1/2"		4 x 1 1/2"	
Material / Material	Stainless Steel		Stainless Steel	
Weight / Peso	7 Kg		12 Kg	
Controller / Controlador	On request		On request	
Water Level / Nivel agua	No		No	
Light / Iluminación	On request		On request	
Flow / Pressure	m3/h	m.c.w	m3/h	m.c.w
Caudal / Presion	2 x 40	12 m	2 x 40	12 m
height / Wide	8m. Height	12m. Wide	8m. Height	12m. Wide

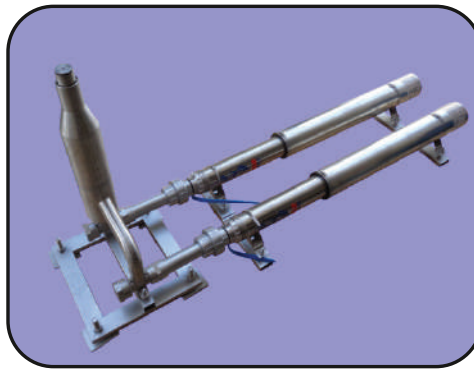
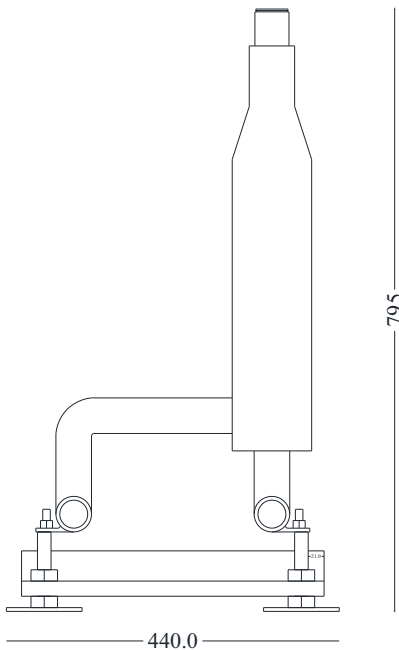

Click the video in You Tube!!

<https://www.youtube.com/watch?v=H1flb9wp1Yk>



Toberas para fuentes de alta tecnología, disponible con control bajo pedido, toberas de gran vistosidad, AISI-304, no son dependientes del nivel del agua.



Nozzles for fountains, available with control on request, showiness nozzles, AISI-304, not water level dependent.



Ajutages pour fontaines, disponible avec contrôle sur demande, et grandioses ajutages, AISI-304, ne sont pas dépendantes du niveau d'eau.

"WATER-MUSIC BI-DIRECTIONAL NOZZLE"

TECHNICAL DATA



<http://www.youtube.com/watch?v=ADxbWEE-ayc>

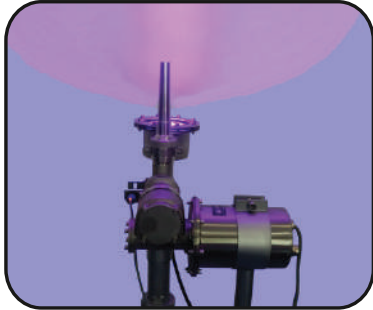

Las Boquillas Switch Bi-Direccionales de **Water Light Tech** son unas boquillas digitales, son precisas y de una gran tecnología, las cuales trasfieren digitalmente precisas señales mediante pulsos hasta el sistema de control de las Boquillas Switch Bi -Direccionales, entonces las boquillas comienzan a girar, consiguiendo el preciso ángulo de giro que ha sido seleccionado, consiguiendo el ángulo deseado. El ángulo de movimiento y la velocidad pueden ser regulados con el sistema digital de control.

Las Boquillas Switch Bi -Direccionales de **Water Light Tech**, consiguen un bonito y agradable efecto acuático, así como una harmónica coreografía acuática, consiguiendo una preciosa forma y por tanto logrando un gran valor artístico, produciendo en el publico que lo esta contemplando una agradable sensación de tal grandioso efecto de agua.

Estas boquillas pueden ser adaptadas a cualquier instalación, grandes y largo lagos, fuentes ornamentales, plaza visitables, interactivas y fuentes musicales. Solo tenemos que tener cuidado con el espacio donde serán instaladas, pues, como ellas tienen un movimiento de giro, necesitan el suficiente espacio para desarrollar su efecto sin producir indeseadas salpicaduras de agua y puedan trabajar correctamente.

La coreografía, es completamente desarrollada en nuestras instalaciones, ajustándola hasta lo más pequeños detalles y consiguiendo que la **Fuente Musical**, se convierta en todo un espectáculo que integre todos los elementos, agua, color, música, laser, pantallas de proyección, en un sistema que funcione en perfecta coordinación y armonía.



Las Boquillas Switch Bi -Direccionales de **Water Light Tech**, son unos dispositivos de alta precisión.



<http://www.youtube.com/watch?v=ADxbWEE-ayc>

The **Water Light Tech** Bi-Directional Switch Nozzle is a digital nozzle, is a precise and a high technology nozzle, which transfers digitally pulse signals precisely from the control system to the Bi -Directional nozzle, then the nozzle starts turning or getting the precise angle marked at the rotation angle desired, the movement angle and the performance speed can be controlled by the digital control system.

The **Water Light Tech** Bi-Directional Switch nozzle, get a very nice water effect as an harmonic water choreography getting a beautiful water shape, thereby achieving a nice artistic value, producing a special delight in the people who are watching and enjoying that so great water effect.



Those nozzles can be adapted and installed everywhere, big and large lakes, **ornamental fountains**, walk square fountains, interactive and **musical fountains**. Just we have to be care ful with the space where to install, because when they start moving we have to keep the enough space so they can work perfectly without producing the unwanted water splash.

The choreography, it is completely developed in our facilities, fitting it to the smallest details and achieving that the **Musical Fountain** turns int o a whole spectacle that integrates all the elements: water, color, music, laser, water projection screens, in to the system that works in the perfect coordination and harmony.

Click Here !!!

<https://www.youtube.com/watch?v=OJY-je00KSM>

The **Water Light Tech** Bi-Directional Switch nozzle is a high-precision device.



TABLA DE TRABAJO // PERFORMACE TABLE	
ARTICLE / ARTICULO	WLT 60088
CONNECTION / CONEXIÓN	G 1 1/2" M
VOLTAGE / VOLTAGE	80VAC +/- 8%
POWER / CONSUMO W / MAX.	530 W
OPERATING PRESSURE / PRESION DE TRABAJO	0-3 Bar.
MAX. PRESSURE	3 Bar / 31 m.c.a.
FLUID OPER. TEMP. / TEMP. MAX TRABAJO	40 C // 104 F
STEPPER MOTOR / MOTOR PASO A PASO	2 PHASE ADJUSTABLE
MATERIAL / MATERIAL	STAINLESS STEEL
IP PROTECTION GRADE / GRADO IP	IP 68
LENGTH / LONGITUD	219 mm
WIDE / ANCHURA	335 mm
HEIGHT / ALTURA	240 mm
WEIGHT / PESO	15 Kg.
CABLE / CABLE LENGHT	2 mts / or on REQUEST



<http://www.youtube.com/watch?v=ADxbWEE-ayc>

Les Switch Bi -Directionnels Adjutages du **Water Light Tech** sont quelques Adjutages digitaux, sont précises et d'une grande technologie, quels transfèrent digitalement des signaux précis grâce à des pools jusqu'au système de contrôle des Switch Bidirectionnels Adjutages, dans ce moment les Adjutages commencent à tourner, en obtenant l'angle précis de tour qui a été sélectionné, en obtenant l'angle désiré. L'angle de mouvement et la vitesse peuvent être réglés par le système digital de contrôle.

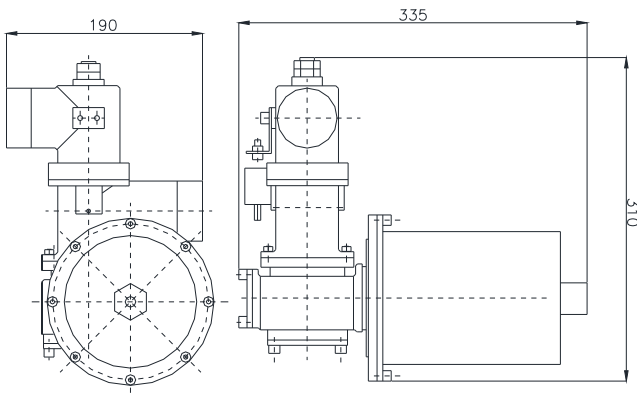
Les Switch Bidirectionnels Adjutages du **Water Light Tech**, obtiennent un joli effet agréable aquatique, ainsi qu'une harmonieuse chorégraphie aquatique, en obtenant une forme belle et c'est pourquoi on leur donne une grande valeur artistique, en produisant chez le public qui le contemple une sensation agréable de tel effet grandiose d'eau.



Ces adjutages peuvent être adaptés à toute installation, grands et de larges lacs, **fontaines ornementales**, places visitables, **interactives** et des **fontaines musicales**. Nous avons à seulement faire l'attention à l'espace où elles seront installées donc comme elles ont un mouvement de tour, ils ont besoin d'un espace suffisant pour développer son effet sans produire d'éclaboussures indésirables d'eau et pouvoir correctement travailler.

La chorégraphie, est complètement développée dans nos installations, en ajustant même les plus petits détails pour obtenir que la **Fontaine Musicale**, il devienne tout un spectacle qui compose tous les éléments, eau, couleur, musique, laser, des écrans de projection, dans un système qui fonctionne avec une coordination parfaite et harmonieuse.

Les Adjutages Bidirectionnels Switch du **Water Light Tech**, ce sont des dispositifs de haute précision.



Click Here !!!

<https://www.youtube.com/watch?v=OJY-ie00KSM>

<http://www.youtube.com/watch?v=ADxbWEE-ayc>

<http://www.youtube.com/watch?v=kanOKOgkEDo>

<http://waterlight-tech.com/Musical-Fountains/>

Fuentes Flotantes / Floating Fountains / Fontaines Flottantes

TECHNICAL DATA



Desde 1/2 HP hasta 60 HP / From 1/2 HP up to 60 HP / de 1/2 HP à 60 HP

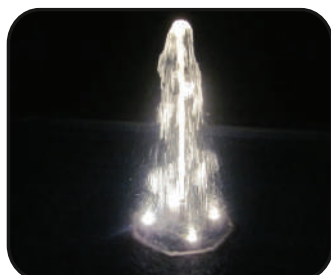

Mini Fuentes Flotantes / Mini Floating Fountains / Fontaines Flottantes Mini

Reference	Model	High Dimen.	Wide Dimen.	Game numbers	Pumps No.	Total Power	Tension	Illumination	Control Panel	Mts. Cable
WLT 74001	WLT-Mini-1	2,00 mts.	4,00 mts.	Volcano Jet	1 unit	0,35 Kw	220/50Hz	4 Uds RGB / W	Included	15 mts.
WLT 74004	WLT-Mini-2	3,50 mts.	1,00 mts.	Snowy Foam	1 unit	0,35 Kw	220/50Hz	4 Uds RGB / W	Included	15 mts.
WLT 74007	WLT-Mini-3	1,00 mts.	5,00 mts.	Calix Jet	1 unit	0,35 Kw	220/50Hz	4 Uds RGB / W	Included	15 mts.

Mid Fuentes Flotantes / Mid Floating Fountains / Fontaines Flottantes Mid

Reference	Model	High Dimen.	Wide Dimen.	Game numbers	Pumps No.	Total Power	Tension	Illumination	Control Panel	Mts. Cable
WLT 74020	WLT-CPP-4MT	5,00 mts.	5,00 mts.	3 Water Games	3 units	2,25 Kw	220/50Hz	6 Uds RGB / W	Included	On Request
WLT 74023	WLT-CPP-7MT	8,00 mts.	8,00 mts.	3 Water Games	3 units	4,50 Kw	220/50Hz	6 Uds RGB / W	Included	On Request
WLT 74026	WLT-VSPF-4MT	5,00 mts.	5,00 mts.	3 Water Games	3 units	3,30 Kw	220/50Hz	6 Uds RGB / W	Included	On Request
WLT 74029	WLT-VSPF-7MT	5,00 mts.	8,00 mts.	3 Water Games	3 units	4,50 Kw	220/50Hz	6 Uds RGB / W	Included	On Request
WLT 74032	WLT-VCZP-4MT	5,00 mts.	6,00 mts.	3 Water Games	3 units	3,30 Kw	220/50Hz	6 Uds RGB / W	Included	On Request
WLT 74035	WLT-VCZP-7MT	5,00 mts.	7,00 mts.	3 Water Games	3 units	4,50 Kw	220/50Hz	6 Uds RGB / W	Included	On Request

Maxi Fuentes Flotantes / Maxi Floating Fountains / Fontaines Flottantes Maxi

WLT 74050	WLT-CPP-Maxi	15,00 mts.	16,00 mts.	3 Water Games	2 units	8,00 Kw	380/50Hz	8 Uds RGB / W	Included	On Request
WLT 74053	WLT-CPVP-Maxi	15,00 mts.	12,00 mts.	3 Water Games	2 units	20,00 Kw	380/50Hz	12 Uds RGB / W	Included	On Request
WLT 74056	WLT-HCPP-Maxi	30,00 mts.	30,00 mts.	3 Water Games	3 units	45,00 Kw	380/50Hz	12 Uds RGB / W	Included	On Request



Las Fuentes Flotantes de Water Light Tech son diseñadas con el fin de embellecer al mismo tiempo que sirven para airear las fuentes, estanques, lagos, etc. donde se instalen.

Hay una gran variedad de modelos además de los que en esta hoja están escritos. desde 1/2 HP hasta 60HP.

Las fuentes Flotantes de Water Light Tech, tienen la posibilidad de iluminación en blanco o en RGB con cambio de color con control remoto. Además se pueden realizar con cambios de alturas y juegos de agua dependiendo del modelo.

The Floating Fountains by Water Light Tech are designed to beautify as well as to serve to get extra air from fountains, ponds, lakes, etc. in the places where they will be built/settled. There are big variety of models in addition to the models mentioned in this technical sheet, from 1/2HP up to 60HP. The Floating Fountains by Water Light Tech, have the possibility of lighting in white and RGB with change of colour from the remote control. Also, they can be manufactured with option of height changes and water games depending on the model.

Les Fontaines Flottantes par Water Light Tech sont conçues pour embellir aussi bien que servir pour recevoir de l'air supplémentaire des fontaines, les étangs, les lacs, etc. dans les endroits où ils seront construits/installés. Il y a la grande variété de modèles en plus des modèles mentionnés dans ce drap technique, de 1/2HP jusqu'à 60HP. Les Fontaines Flottantes par Water Light Tech, avez la possibilité de vous allumer dans le blanc et le RGB avec le changement de couleur de la télécommande. Aussi, ils peuvent être fabriqués avec l'option de changements de hauteur et de jeux d'eau selon le modèle.

“WATER WALK TRANSITABLES” EQUIPOS / “WATER WALK DRY FOUNTAIN” DEVICES

“WATER WALK FONTAINES SÈCHES” KITS

TECHNICAL DATA



Water Walk Square VX, 400x400



REFERENCE	MODEL	QUICK SWITCH	TYPE OF LIGHT FIXTURE	Wattios	Tesion	Temp	Intensidad	Peso	G. Proteccion
				Watts	Voltage	Temp	Intensity (lm)	Weight	P- Grade
WLT 60034VXG	Water Walk Square VX, 400x400 RGBW, 2mts. 5x1mm ²	Yes / NC or NO / Or Mix	Crown Led 6x3W RGBWW Warm Int.	18W	12VDC	RGBW	1800-2100lm	11,5 Kg	IP 68
WLT 60034VXJ	Water Walk Square VX Jet, 400x400 RGBW, 2mts. 5x1mm ²	Yes / NC or NO / Or Mix	Crown Led 6x3W RGBWW Warm Int.	18W	12VDC	RGBW	1800-2100lm	11,5 Kg	IP 68
WLT 60034VXF	Water Walk Square VX Fog, 400x400 RGBW, 2mts. 5x1mm ²	Yes / NC or NO / Or Mix	Crown Led 6x3W RGBWW Warm Int.	18W	12VDC	RGBW	1800-2100lm	11,5 Kg	IP 68
WLT 770814BWU	Water Walk B Crown, 300x300 mm, 45W/24VDC, RGBW, 2mts. 5x1,0mm ²	No / On request	Crown Led 9x5WRGBWW Warm Int.	45W	24VDC	RGBW	3500-4000 lm	4,4 Kg	IP 68
WLT 770814BWJ	Water Walk B Crown Jet 1", 300x300 mm, 45W/24VDC, RGBW, 2mts. 5x1,0mm ²	No / On request	Crown Led 9x5WRGBWW Warm Int.	45W	24VDC	RGBW	3500-4000 lm	4,4 Kg	IP 68
WLT 770814BWF	Water Walk B Crown Fog, 300x300, 45W/24VDC, RGBW, 2mts. 5x1,0mm ²	No / On request	Crown Led 9x5WRGBWW Warm Int.	45W	24VDC	RGBW	3500-4000 lm	4,4 Kg	IP 68



Los Equipos Water Wall, son unos Kit para las fuentes transitables, secas y/o también interactivas. Están fabricados en acero inoxidable, hay gran variedad de diseños y posibilidades, pueden llevar distintas opciones de toberas, así como de iluminación, que puede ser, blanca, RGB o RGBW, mediante focos VX o Coronas de led.

Fácil instalación y programación.

Se comercializa en variantes, chorros directos o con válvulas switch de rápida respuesta, además, gracias al cuadro de control, se pueden incluir, variadores de frecuencia para conseguir un ajuste exacto en cada chorro, así como de una coreografía perfecta y vistosa.

Possibilidad de diseños especiales bajo pedido.



The Water Wall Equipment, are a Kit for trafficable, dry and/or also interactive fountain. They are made of stainless steel, there are several variety of designs and possibilities, they can carry different options of nozzles, as well as lighting, which can be, white, RGB or RGBW, using VX light fixtures or Crown of LED.

Easy installation and programming.

It is sold in different variants, direct jets or with switch quick valves, and thanks to the control pannel, can be included, frequency inverters to achieve an accurate adjustment in each jet, as well as a perfect and colorful choreography.

Possibility of special designs on request.

“WATER WALK TRANSITABLES” EQUIPOS / “WATER WALK DRY FOUNTAIN” DEVICES

“WATER WALK FONTAINES SÈCHES” KITS

TECHNICAL DATA



Les Equipements Water Wall, sont des Kit pour les fontaines carrossables, sèches et/ou aussi interactives. Ils sont fabriqués en acier inoxydable, il y a une grande variété de modèles et possibilités, ils peuvent avoir différentes options de ajutages, ainsi que d'éclairage, qui peut être, blanc, RGB ou RGBW, par des projecteurs VX ou Couronnes à led.

Installation et programmation faciles.

Il est commercialisé en deux variantes, directe ou avec électrovannes Switch à réaction rapide, en plus, grâce au tableau de contrôle, au moyen des variateurs de fréquence, on peut être obtenue, un ajustement précis dans chaque jet, ainsi que d'une chorégraphie parfaite et très spectaculaire.

Sur demande, nous pouvons fabriquer des conceptions spéciales selon les besoins des clients.

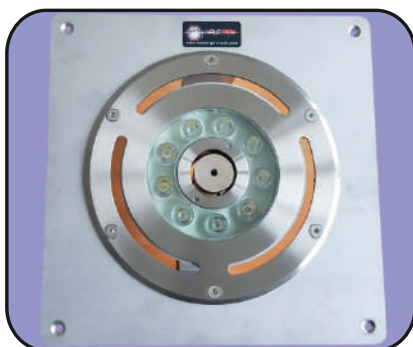

Water Walk B Crown Fog, 300x300



Water Walk B Crown Jet, 300x300

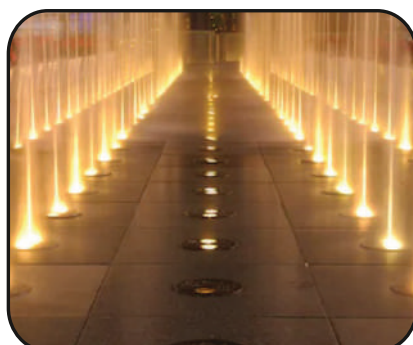

Sumergibles "BOMBAS" / "PUMPS" Submersible / Sumersibles "POMPES"

TECHNICAL DATA



Filtros especiales para "Bombas Sumergibles" / Special filters for "Sumersible PUMPS" Submersible / Spéciaux Filtres pour Sumersibles "POMPES"

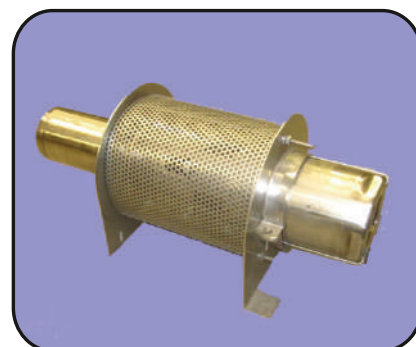

Bombas sumergibles para todo tipo de caudales y presiones, fabricadas en Acero inoxidable, adaptadas para altas prestaciones y larga durabilidad. Fabricación de todo tipo de pre-filtros para adaptar las bombas a sus diferentes usos y prestaciones



Submersible pumps for the entire different works of flow and pressures, made in Stainless steel, adapted for high services and long durability. Manufacture of different pre-filters to adapt the pumps to different uses



Les pompes submersibles pour les différents travaux d'écoulement et de pressions, faites dans l'Acier inoxydable, se sont adaptées pour de hauts services et une longue durabilité. La fabrication de différents pré-filtres pour adapter les pompes à de différentes utilisations



Disponibles Filtros especiales para todas las "Bombas Sumergibles"
Available the Special filters for "Sumersible PUMPS" Submersible
Spéciaux Filtres pour Sumersibles "POMPES"

DATOS TÉCNICOS DE LAS BOMBAS BASICAS

TECHNICAL INFORMATION FROM BASIC PUMPS

INFORMATIONS TECHNIQUES DES BASIC POMPES

Reference	Model	Voltage	Connection	Caudal, Flow (Q)													Weight	
				M3/h		0	1,2	3,6	6,0	8,4	9,6	12,0	13,2	15,6	18,0			
				P1 (Kw)	1 (A)	Altura, High H (m)												
WLT 734001	RXM 1	1x230 V	Rp 1 1/4"	0,25	1,3	7,5	6,5	5	3,5	2	1							4,7Kg
WLT 734002	RXM 2	1x230 V	Rp 1 1/4"	0,37	2	10	9,5	8	6,5	5	4,5	2,5	2					5,8Kg
WLT 734003	RXM 3	1x230 V	Rp 1 1/4"	0,55	3,6	12	11,5	9,5	8	6,5	5,5	3,5	3					7,4Kg
WLT 734004	RXM 4	1x230 V	Rp 1 1/2"	0,75	5,4	16	15	13	11,5	9,5	8,5	6,5	5,5	4				8,6Kg
WLT 734005	RXM 5	1x230 V	Rp 1 1/2"	1,1	7,5	20	19,5	17,5	15,5	13,5	12,5	10	9	7	5			9,0Kg

Reference	Model	Voltage	Connection	Caudal, Flow (Q)													Weight	
				M3/h		0	3	6	9	12	15	18	21	24				
				P1 (Kw)	1 (A)	Altura, High H (m)												
WLT 734011	XM 8/35	1x230 V	Rp 1 1/2"	0,55	3,3	8,4	7,5	6,5	5,2	3,7	2							9,5Kg
WLT 734012	XM 10/35	1x230 V	Rp 1 1/2"	0,75	5	10	9,5	8,5	7,2	5,8	4	2						10,8Kg
WLT 734013	XM 8/50	1x230 V	Rp 2"	0,55	3,5	6	5,5	5	4,4	3,6	2,8	2	1				9,4Kg	
WLT 734014	XM 10/50	1x230 V	Rp 2"	0,75	5	7,5	7	6,5	5,8	5	4	3,2	2,4	1,5			10,6Kg	

Reference	Model	Voltage	Connection	Caudal, Flow (Q)													Weight	
				M3/h		0	3	6	9	12	15	18	21	24	27	30		36
				P1 (Kw)	1 (A)	Altura, High H (m)												
WLT 734019	MC 10/50	3X380	Rp 2"	0,75		12	10,7	9,7	8,7	7,8	6,8	5,9	5	4	3	2		9,5Kg
WLT 734020	MC 15/50	3X381	Rp 2"	1,1		15	14	13	12,3	11,5	10,5	9,7	8,8	8	7	6,2	4,5	10,5Kg

Reference	Model	Voltage	Connection	Caudal, Flow (Q)													Weight	
				M3/h		0	0,7	1,8	2,9	3,6	4,3	5,4	6,5	7,2	9	11		13
				P1 (Kw)	1 (A)	Altura, High H (m)												
WLT 730150	Kp 150	1x230 V	Rp 1 1/4"	0,3	1,3	5,2	4,8	4,3	3,9	3,6	3,3	2,9	2,4	2				6,2Kg
WLT 730250	Kp 250	1x230 V	Rp 1 1/4"	0,5	2,3	7,4	7,3	7	6,7	6,3	6	5,3	4,6	4,1	2,8			7,0Kg
WLT 730350	Kp 350	1x230 V	Rp 1 1/4"	0,7	3,2	9	8,7	8,3	7,9	7,6	7,3	6,9	6,4	6,1	5,1	3,8	2,4	7,7Kg

Reference	Model	Voltage	Connection	Caudal, Flow (Q)													Weight	
				M3/h		0	4	5	7	9	11	14	16	18	22	25		29
				P1 (Kw)	1 (A)	Altura, High H (m)												
WLT 730004	AP 12.40.04	1x230 V	Rp 1 1/2"	0,7	3	10,7	9,4	8,7	7,9	7	6	3,8	2,5					11,0Kg
WLT 730006	AP 12.40.06	1x230 V	Rp 1 1/2"	0,9	4,4	12,9	12	11	10	9,1	8,2	5,9	4,7	3,4				11,0Kg
WLT 730008	AP 12.40.08	1x230 V	Rp 1 1/2"	1,3	5,9	14,5	13	13	12	11	10	8,2	7,1	5,7	2,9			13,2Kg
WLT 730011	AP 12.50.11	1x230 V	Rp 2"	1,7	8,5	15,9	15	15	14	13	13	11,1	10,3	9,4	7,8	6	4,1	15,7Kg

"PASAMUROS" Acero Inox. / "STUB-UPS" Stainless Steel / "PASSE-CÂBLE" Acier Inox.

TECHNICAL DATA

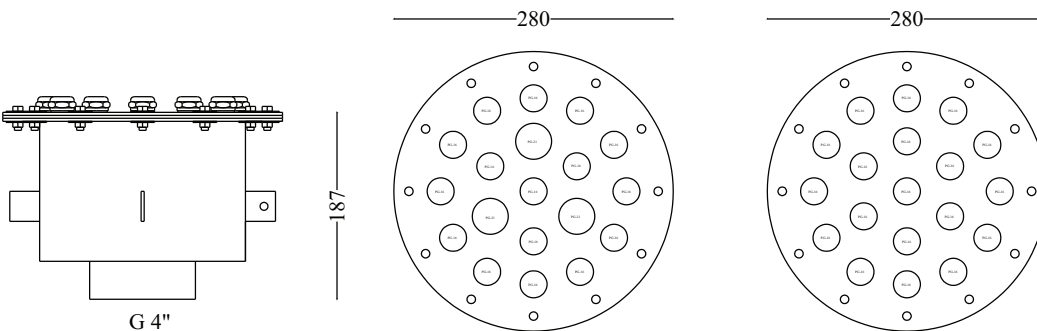
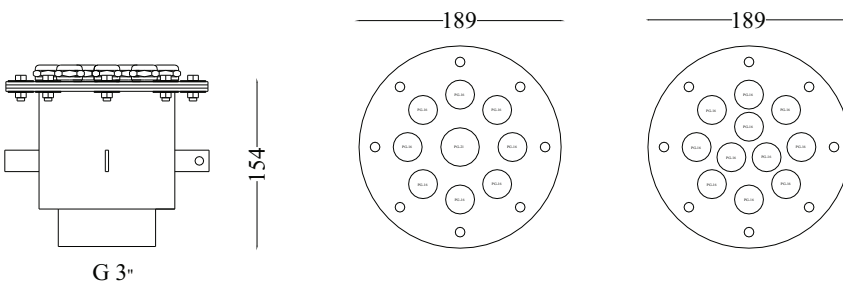
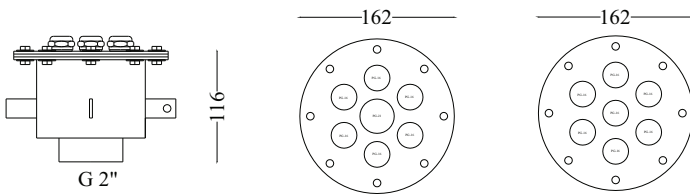
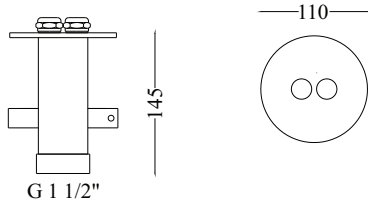
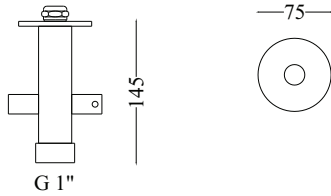

MODEL	DESCRIPCION	DESCRIPTION	WEIGHT
WLT 512071	Pasamuros conexión, 1" M, 1 PG-16	Stub-Up 1" M, Connection, 1 PG-16	0,450 Kg
WLT 512072	Pasamuros conexión, 1 1/2" M, 2 PG-16	Stub-Up 1 1/2" M, Connection, 2 PG-16	0,550 Kg
WLT 512073	Pasamuros conexión, 1 1/2" M, 1 PG-21	Stub-Up 1 1/2" M, Connection, 1 PG-21	0,550 Kg
WLT 512074	Pasamuros conexión, 2" H, 7 PG-16	Stub-Up 2" F Connection, 7 PG-16	1,750 Kg
WLT 512075	Pasamuros conexión, 2" H, 6 PG-16 + 1 PG-21	Stub-Up 2" F Connection, 6 PG-16 + 1 PG-21	1,750 Kg
WLT 512076	Pasamuros conexión, 3" H, 11 PG-16	Stub-Up 3" F Connection, 11 PG-16	2,550 Kg
WLT 512077	Pasamuros conexión, 3" H, 8 PG-16 + 1 PG-21	Stub-Up 3" F Connection, 8 PG-16 + 1 PG-21	2,550 Kg
WLT 512078	Pasamuros conexión, 4" H, 19 PG-16	Stub-Up 4" F Connection, 19 PG-16	5,150 Kg
WLT 512079	Pasamuros conexión, 4" H, 16 PG-16 + 3 PG-21	Stub-Up 4" F Connection, 16 PG-16 + 3 PG-21	5,150 Kg



IP 68

Cotas en mm
 Measures in mm
 Mesures en mm



Pasamuros, fabricados en Acero inoxidable, diseñados para su colocación subacuática. Estos se colocan encastrados en el hormigón de la base de la fuente y se conectara la parte inferior de los pasamuros con la tubería de la dimensión exacta hasta la sala de bombeo o cuarto de maniobra. Se han diseñado para poder combinarse y usar el numero salidas deseado.



Stub-Ups made in Stainless steel and are designed for underwater use. Stub-Ups should be installed into the concrete and will be connected through a pipe up to technical room. Were designed to be used with different outlets according to satisfy the customer's needs.



Passes-Câbles sont fabriqués en Acier inoxydable et sont conçues pour l'utilisation subaquatique. Les Passes-Câbles seront mis durant les travaux du bassin, ils sont habituellement noyés dans le béton. La partie inférieure du Passe-Câble est connectée avec un tube à raccord qui le relie avec la salle de pompage. Les Passes-Câbles pour câbles immergés ont été créés pour pouvoir se combiner selon le nombre de sorties nécessaires.

“ACCESORIOS” / “ACCESSORIES” / “ACCESSOIRES” .

TECHNICAL DATA



“ROTULAS” / “BALL JOINTS” / “ROTULE” .

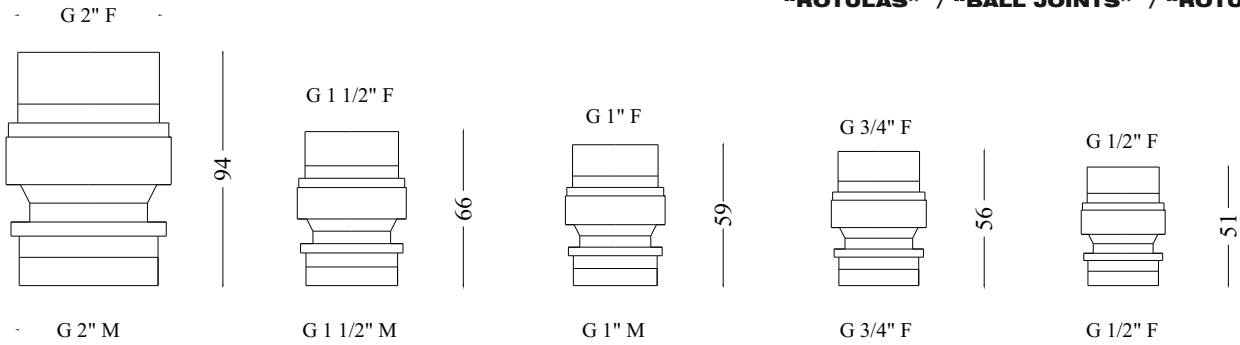

MODEL	ROTULAS & BRIDAS	BALL JOINTS & FLANGES	WEIGHT
WLT 511285	Rotula 1/2" M-H Laton Para Toberas	Ball Joint 1/2" M-F Brass, For nozzles	0,115 Kg
WLT 513485	Rotula 3/4" M-H Laton Para Toberas	Ball Joint 3/4" M-F Brass, For nozzles	0,142 Kg
WLT 511086	Rotula 1" M-H Laton Para Toberas	Ball Joint 1" M-F Brass, For nozzles	0,235 Kg
WLT 511087	Rotula 1" M-H Acero Inox. Para Toberas	Ball Joint 1" M-F Stainless Steel, For nozzles	0,235 Kg
WLT 511588	Rotula 1 1/2" M-H Laton Para Toberas	Ball Joint 1 1/2" M-F Brass, For nozzles	0,415 Kg
WLT 512089	Rotula 2" M-H Laton Para Toberas	Ball Joint 2" M-F Brass, For nozzles	0,775 Kg
WLT 511082	Brida regulable 1" Macho x 1" Hembra, Acero inox	Adjustable Flange 1" Male x 1" Female, Stainless Steel	0,695 Kg
WLT 511083	Brida regulable 1" Macho x 1" Hembra, Acero inox	Adjustable Flange 1" Male x 1" Female, Stainless Steel	1,145 Kg
WLT 511084	Brida regulable 1" Macho x 1" Hembra, Acero inox	Adjustable Flange 1" Male x 1" Female, Stainless Steel	1,500 Kg

“BRIDAS AJUSTABLES” / “ADJUSTABLE FLANGE” / “BRIDE RÉGLABLE” .

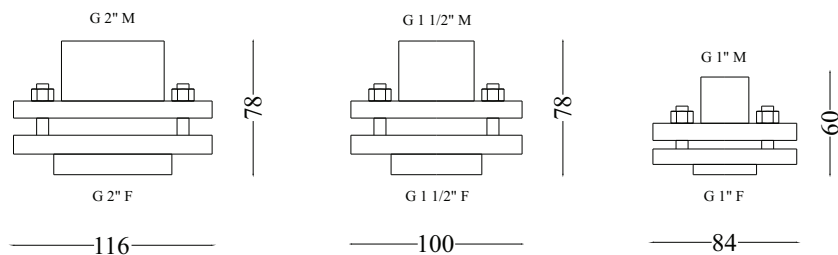

Cotas en mm
Measures in mm
Mesures en mm



Rotulas y Bridas de regulación fina, fabricadas en Latón y Acero inoxidable, diseñadas para la regulación y colocación de las toberas que lo necesiten en su correcta inclinación. Estas se colocan en la base de la tobera para poder corregir el ángulo de salida.



Ball joints and Flanges for the exact angle regulation, made in Brass and Stainless steel, designed for the regulation and laying of the nozzles that need to be correct their right inclination. These are placed in the base of the nozzles to be able to correct the water stream outlet angle.



Rotules et les Brides de régulation fine, fabriquées dans Laiton et Acier inoxydable, dessinées pour la régulation et la pose des tuyères qui ont besoin de cela dans son inclinaison correcte. Celles-ci se placent dans la base de la tuyère pour pouvoir corriger l'angle de sortie.

"ACCESORIOS" / "ACCESSORIES" / "ACCESSOIRES" .

TECHNICAL DATA



"CAJAS DE CONEXIÓN" / "CONNECTION BOXES" / "BOÎTES DE JONCTION" .



	"CAJAS DE CONEXIONES" ACERO INOXIDABLE	"CONNECTION BOXES" STAINLESS STEEL	Measures		Entradas	Peso	Grado P
	POSIBLES MODELOS ESPECIALES	AVAILABLE SPECIAL MODELS	Wide	Height	Inlet	Weight	P. Grade
WLT 512084	Caja de conexiones, 4 PG-16, tapa metacrilato	Connetion Box, 4 PG-16, methacrylate cover	162 mm	65 mm	4 PG-16	1,500 Kg	IP68
WLT 512085	Caja de conexiones, 4 PG-16, tapa en inox	Connetion Box, 4 PG-16, stainless steel cover	162 mm	65 mm	4 PG-16	1,550 Kg	IP68
WLT 512088	Caja de conexiones, 8 PG-16, tapa metacrilato	Connetion Box, 8 PG-16, methacrylate cover	162 mm	95 mm	8 PG-16	2,150 Kg	IP68
WLT 512089	Caja de conexiones, 8 PG-16, tapa en inox	Connetion Box, 8 PG-16, stainless steel cover	162 mm	95 mm	8 PG-16	2,200 Kg	IP68

"TOMAS DE FONDO" / "BOTTOM DRAIN" / "CANALISATION DE FOND" .



	"TOMAS DE FONDO" ACERO INOXIDABLE	"BOTTON DRAIN" STAINLESS STEEL	Measures		Conexión	Peso
	POSIBLES MODELOS ESPECIALES	AVAILABLE SPECIAL MODELS	Wide	Height	connection	Weight
WLT 51220	Toma de fondo 2"	Botton Drain 2"	162 mm	129 mm	2" F	1,700 Kg
WLT 51221	Toma de fondo 2 1/2"	Botton Drain 2 1/2"	162 mm	129 mm	2 1/2" F	1,750 Kg
WLT 51222	Toma de fondo 3"	Botton Drain 3"	189 mm	154 mm	3" F	2,400 Kg
WLT 51223	Toma de fondo 4"	Botton Drain 4"	280 mm	187 mm	4" F	5,000 Kg



"REBOSADERO" / "OVERFLOW" / "TROP-PLEIN" .

"Adaptable a todo tipo tubos" / "Adjustable to every kind of pipes"
"Adaptable à toute espèce des tubes" .



	"REBOSADEROS" ACERO INOXIDABLE	"OVERFLOW" STAINLESS STEEL	Measures		Conexión	Peso
	POSIBILIDAD NIPLES MEDIDAS ESPECIALES	AVAILABLE SPECIAL HEIGHT NIPPLES	Wide	Height	connection	Weight
WLT 51224	Rebosadero Terminal, adaptable para tubos, 2"H	Overflow Terminal, adaptable for pipes, 2"F	165 mm	118 mm	2" F	1,490Kg
WLT 51225	Rebosadero Terminal, adaptable para tubos, 2 1/2"H	Overflow Terminal, adaptable for pipes, 2 1/2"F	165 mm	120 mm	2 1/2" F	1,510 Kg

"APORTES DE CAUDAL" / "EXTRA FLOW INLETS" / "DONNÉES DE DÉBIT" .



	APORTES EXTRA DE CAUDAL	EXTRA FLOW FOR	Measures		Conexión	Peso
	PARA CASCADAS NATURALES	NATURAL CASCADES	Wide	Height	connection	Weight
WLT 51216	Aporte extra para cascadas, aporte extra de caudal 2"	Water Input for Water fall, extra flow for Natural Cascades 2"	68 mm	140 mm	2" F	0,450 Kg
WLT 51217	Aporte extra para cascadas, aporte extra de caudal 2 1/2"	Water Input for Water fall, extra flow for Natural Cascades 2 1/2"	78 mm	150 mm	2 1/2" F	0,750 Kg
WLT 51218	Aporte extra para cascadas, aporte extra de caudal 3"	Water Input for Water fall, extra flow for Natural Cascades 3"	111 mm	154 mm	3" F	0,980 Kg



Accesorios para fuentes, cajas de conexión, diseñadas para conexión eléctrica de los cables de la fuente en Acero inoxidable. Tomas de fondo, rebosaderos y aportes de caudal fabricados en Acero inoxidable, para el vaciado, la regulación de nivel, llenado de las caídas de las cascadas naturales de agua.



Accessories for fountains, connection boxes, designed for electrical connection of the cables in the fountain made in Stainless steel. Botton drains, overflows and extra flow inlets made in Stainless steel, for the emptying, water level regulation, filled for the falls of the natural cascades of water.



Des accessoires pour des fontaines, des boîtes de connexion, dessinées pour une connexion électrique des câbles de la fontaine dans l'Acier inoxydable. Canalisation de fond, trop-plein et des apports de débit fabriqués dans un Acier inoxydable, pour le moulage, la régulation de niveau, rempli des chutes des cascades naturelles d'eau.



MONDI IMPIANTI

Via G. Ferraris, 8 - 30038 Spinea (VE) Italia

Tel +39 041 5411452 - WhatsApp +39 328 7736979

info@mondiimpianti.com - www.mondiimpianti.com